



GO GROOVE IT!

CATALOGUE 2025



No. 973
ROLLING HAND
GROOVER

CLIP - ON
FOOT PLATE
FOR CURVES



No. 957
DETAILHAND
GROOVER

No. 958
3.5mm

HIGH CARBON STEEL
HARDENED & GROUND
STANDARD U - BLADES



Every Flooring Installation Deserves the **"GILT EDGE"** Finish



FULLY UNDERCUTS INSIDE CORNER AREAS

HEIGHT ADJUSTMENT

UNDERCUTS DOORS AS THICK AS 1 3/4" WITHOUT REMOVAL

U.S. PATENT NO. 7,739,802 B2

Slip-Proof Height Adjustment



TOP KNOB - SET HEIGHT
SIDE KNOB - LOCK HEIGHT

No. 835 Heavy-Duty Undercut Saw

This saw comes with a larger 6 1/2" diameter blade that undercuts doors in place, and a masonry blade to undercut hearths. A diamond blade (No. 822) is available for undercutting tile and stone. Features a more powerful 13 AMP motor, dust control, threaded rod height adjustment that won't slip, and rugged aluminum ratchet handle. Undercuts most everywhere including inside corners. Volts: 120 - AMPs: 13.

Order No.	Description	Weight
835	Heavy-Duty Undercut Saw	21 lb.
821	Carbide-Tipped Blade	11 oz.
836	Carbide-Tipped Blade	11 oz.
837	Dust Cover	7 oz.



INCLUDES CASE, CARBIDE AND MASONRY BLADES

Pivoting Ratchet Handle



HANDLE TILTS BACK AND LOCKS SOLID



HANDLE ADJUSTMENT

No. 837
DUST COVER
SOLD SEPARATELY



Replacement Blades for Crain No. 835 Saws:

No. 822 Diamond:
Available for cutting stone

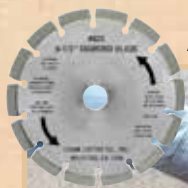

Tile & Stone

No. 805 Masonry:
Dry-cut composition blade



Masonry

No. 836 Carbide:
General wood cutting



No. 821
Carbide



Pocket Doors



No. 575

No. 556

No. 575 Multi-Undercut Saw

This versatile saw undercuts along walls, door jambs, under toe spaces, and will also undercut inside corners.

The height of cut is easily adjustable from flush to one inch above the floor. The large, flat base prevents tipping and assures accurate, level cutting. The angled depth gauge allows undercutting at a "straight-on" or a 45° angle. The visual scale provides precision depth control at 1/8" increments.

Each saw comes with a 36-tooth No. 556 Carbide Blade. The blade is bell-shaped for added rigidity and should not be used on any other saw. Also comes with custom molded carrying case, a hex key for blade removal, and detailed instructions.

Order No.	Description	Volts	Amps.	Weight
575	Multi-Undercut Saw	120	6.2	11 lb.
556	Carbide Blade (36 tooth)	---	---	6 oz.



Corners



Toe-Spaces



No. 787
Carbide

No. 777

No. 777 Toe-Kick Saw

This improved saw has a hinged depth adjustment plate and adjustment arm with five settings for common underlayment thicknesses including 1/4", 3/8", 1/2", 5/8", or 3/4". Cuts flush to the inner wall of the cabinet to remove old underlayment. The saw includes a clutch mechanism that may disengage to reduce kickback. Comes with No. 787 3 3/8" Carbide-Tipped Blade for wood cutting. The No. 789 Toe-Kick Saw Diamond Blade is sold separately for cutting tile or grout to a fixed depth of 3/8". Do not use any other blades with the saw.

Order No.	Description	Volts	Amps.	Weight
777	Toe-Kick Saw	120	11	13.7 lb.
787	Carbide-Tipped Blade	--	--	2 oz.
789	2 5/8" Diamond Blade	--	--	2 oz.

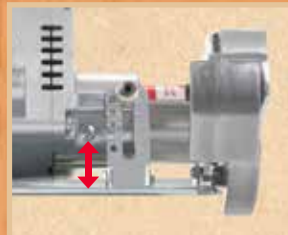

Hinged Plate



Depth Control



No. 789 Diamond



Tile
Repair

No. 520 Swivel-Lock Stretcher 60° of swivel with 5 lock points!

The Swivel-Lock Stretcher gives you the benefits of both straight and swivel heads. The head has 60° of free swivel for patterned carpet. Depress the built-in lock pin, and you can lock the swivel in 5 convenient positions. Lock in the straight position for square stretching, or at 15° for most angle stretching. There's even a 30° setting for extreme angles found in "L" shaped living/dining rooms. Also features a stretch lock button for partial stretches. Pin depth adjustment bar allows variable pin depth penetration for different carpet thicknesses. Adjusts with two screws in the pin plate. Comes with Lever Extension Tube and Folding Tail Block. Sold in double case model only.

Order No.	Description	Weight
520	Swivel-Lock Stretcher	59 lbs.
1520-Z	Swivel-Lock Head ONLY	12 lbs.

Swivel-Lock Head



Swivels parallel to wall on angle stretches.

Swivel-Lock Head

Smooth Extension

Stretch Lock

Folding Tail Block

No. 520

No. 520 Swivel-Lock Stretcher includes:



Folding Tail Block

- Folds for corners
- Locks for posts
- Spans 20" flat



NEW

Lever Extension Tube

- Hand lever adjustment
- Unlocks when lifted off floor for fast adjustment

Nos. 499 and 500 Power Stretchers

Our fixed head stretcher has the features that you would expect in a more expensive power stretcher. Comes complete with push-button stretch lock, Auto-Lok tube, 3 extension tube sections, 1 transfer tube section, folding tail block, and your choice of cases (see next page). Adjusts from 37" to 23 ft. and can be lengthened by adding additional extension tubes (No. 502). The No. 500 has an adjusting knob on the top of the driving head with a visual pin depth setting gauge. Just set the dial to the desired pin depth and you're ready to stretch. No screws or screwdrivers required.

Order No.	Description	Cases	Weight
499	Double Case Stretcher	2	59 lbs.
500	Single Case Stretcher	1	53 lbs.



Auto-Lok Tube Button Adjustment

Visual Pin Depth Knob (Nos. 499 & 500 ONLY!)

Side-kicking Platform

Stretch Lock

Folding Tail Block

No. 499
No. 500

Smooth Extension

Helpful Cases



No. 497

ROLL



No. 499 Double Case Stretcher

Our double case design includes a head case with wheels and a tube case that hooks onto the head case for easy transport. The cases are easily split apart for carrying. Both cases are durably constructed and feature recessed latches and handles. The double case set holds all the stretcher components for the No. 499 or 520 shown on the previous page.

Cases and components also sold separately. No. 498E Empty Tube Case holds an Auto-Lok Tube and 3 Extension Tubes. No. 499E Empty Combo Cases hold a Crain Power Stretcher, Auto-Lok Tube, transfer tube, and up to 5 Extension Tubes. Also hold Roberts #10-239.

Order No.	Description	Weight
499	Double Case Stretcher	59 lbs.
497	Case w/Driving Head, Transfer Tube, & Folding Tail Block	32 lbs.
498	Tube Case w/3 Extension Tubes & Auto-Lok	27 lbs.
498E	Empty Tube Case	7 lbs.
499E	Empty Combo Cases (Head & Tube)	18 lbs.

No. 498



Double Case Stretcher

- Head case has wheels
- Tube case can hook on or be carried separately

SPLIT



CARRY



No. 500 Single Case Stretcher

Our single case design comes with wheels for easy transport. The No. 500 case holds a Driving Head, Folding Tail Block, Transfer Tube, 3 Extension Tubes, and one Auto-Lok Tube. The single case design saves money.

No. 503 Empty Single Case holds the Stretcher components listed above for the No. 500, or up to 6 Extension Tubes. (Note: you must have new style narrow lifting handle to hold all of these stretcher components.)

Order No.	Description	Weight
500	Single Case Stretcher	53 lbs.
503	Stretcher Carrying Case	11 lbs.
1500-U	Driving Head ONLY	12 lbs.

Stretcher Accessories

No. 501 Auto-Lok Tube

Adjust the length of stretcher tubes fast with the Auto-Lok Tube. Just push back on your tubes to extend, push buttons and pull back to shorten. Works with other Junior Power Stretchers with standard size poles.

Order No.	Description	Weight
501	Auto-Lok Tube	7 lbs.

No. 510 Lever Extension Tube

The top hand lever permits fast extension or retraction of the tail. The bottom floor lever unlocks when the stretcher head is lifted off the floor, allowing the head to be extended or retracted. Reduces back twisting necessary to activate the buttons of an Auto-Lok tube.

Order No.	Description	Weight
510	Lever Extension Tube	7.82 lbs.

Extension Tube Sections

Extra extension tubes give you extra length for big jobs. Available in steel and aluminum models.

Order No.	Description	Weight
502	3' Extension Tube	6.00 lbs.
516	3' Aluminum Stretcher Tube	3.26 lbs.
517	5' Aluminum Stretcher Tube	6.00 lbs.

No. 500Z and 520Z Cotton Grip Heads

Helps protect Berber and low-level commercial carpets.

Order No.	Description	For Stretcher	Weight
500Z	Cotton Head	499-500	4 lbs.
520Z	Cotton Head	520	4 lbs.

No. 1500-23 Folding Tail Block

This tail block folds for stretching off outside corners in "L"-shaped rooms, and posts. The tube locks for stretching off posts. Spans 20" flat. Also has wheels to move it down the wall fast. Works with all Crain Stretchers, and other junior stretchers with standard poles.

Order No.	Description	Weight
1500-23	Folding Tail Block	4.5 lbs.

NEW



No. 501

No. 510

No. 502

No. 516 - 3'

No. 517 - 5'

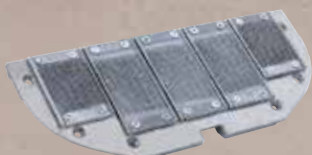

No. 500Z



No. 520Z



No. 1500-23



Stretches off posts & corners!

U.S. PAT. NO. 7,451,961 B2 & 7,722,012 B2



CRAIN

Stretching Tools



STRETCH WITHOUT TUBES!



No. 515

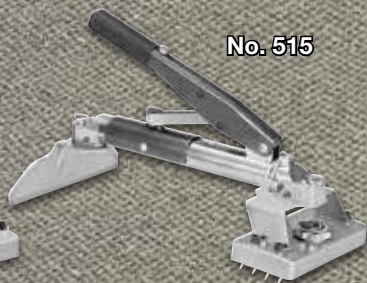

No. 515 Mini-Stretcher No. 519 Tall Seam Repair Legs

The mini-stretcher is great for pattern-matching, fast restretching without tubes, and seam repair. Features include stretch-lock button, two fully pivotable gripper heads, open top wall blade for fast tucking, and carrying case. Gripper heads and wall blades are quickly connected onto either end using the push-button lock pins. Tall seam repair legs that create a 9" high by 10" wide work area beneath to run an iron are sold separately (No. 519).

Order No.	Description	Weight
515	Mini-Stretcher	22 lbs.
519	Tall Seam Repair Legs	3 1/2 lbs.



9" Clear Height
No. 519 Tall Seam Repair Legs sold separately

PATTERN MATCH & REPAIR SEAMS!



No. 161 Notched



No. 162 Plain

No. 161 Notched Carpet Spreader

Our notched carpet spreader is made from flexible brushed stainless steel. The blade is flexible enough to be used in tight spaces as a glue spreading trowel tool. The blue plastic handle is ergonomically contoured. Blade width: 12 inches.

Order No.	Description	Weight
161	Notched Carpet Spreader	8 oz.

No. 162 Plain Carpet Spreader

Our plain spreader is made with thicker 16 gauge plated steel without notches. This creates a better tucking tool that won't bend and easily slides at the gully, because it won't catch yarns. The black plastic handle is ergonomically contoured. Blade width: 10".

Order No.	Description	Weight
162	Plain Carpet Spreader	8 oz.



No. 507



No. 507 Stairway Stretcher

Working from the top of the stairway down, it stretches the carpet fully - with gravity working with you, it's easier! Gives a tighter uniform stretch, without the usual sore knees.

Order No.	Description	Weight
507	Stairway Stretcher	14 1/2 lbs.



FROM TOP STAIR - STRETCH



TUCK

Carpet Kickers



CRAIN

No. 605 Deluxe Knee Kicker

Our deluxe kicker features a high profile body that more easily spans stretcher tubes, a soft synthetic rubber grip, a recessed trigger for length adjustment, a thicker seamless bumper pad, and internal power rods to support the pin plate.

Length is adjustable with 5 settings from 18 $\frac{1}{2}$ " to 22 $\frac{1}{2}$ ". Head includes 3 nap grips and pin plate with 16 hardened steel pins. Pin dial provides 9 pin depths for various carpets. Comes with cap cover. Bumper, nap grips and pin plate are replaceable.

Order No.	Description	Parts per	Wt. Ea.
605	Knee Kicker	1	5.89 lbs.
1505-K	Gripper Inserts	3	2 oz.
1601-B	Pin Plate	1	3 oz.



Power rods

No. 605

Comfort Knees™ Knee Pads



Comfort Knees™ Knee Pads

Protection and comfort for kneeling and knee kicking in one great pad. More information on page 30.

No. 445

No. 445 Knee Kicker

This classic kicker has a recessed trigger for length adjustment in five settings from 17 $\frac{3}{4}$ " to 21 $\frac{3}{4}$ ". Gripping head includes 3 nap grips, and pin plate with 16 hardened steel pins. Pin dial provides 9 pin depth adjustments for various carpets. Seamless bumper cushion, nap grips and pin plate are replaceable. Comes with cap cover.

Order No.	Description	Parts per	Wt. Ea.
445	Knee Kicker	1	3 lbs.
1505-K	Gripper Inserts	3	2 oz.
1601-B	Pin Plate	1	3 oz.



No. 505

No. 505 Knee Kicker

No. 525 Wide Knee Kicker

This family of kickers with telescoping tube construction are some of the most durable available. The No. 505 and No. 525 have four length adjustments (approximately 21" minimum to 25" maximum)

The popular No. 505 has 3 nap grips, and 4 rows of 16 total hardened steel pins. Pins are adjustable to 9 different depth settings for various carpets. Internal power rods support the pin plate.

The No. 525 is a wider kicker with a fifth row of pins (19 total pins) and a fourth nap grip that moves a wider section of carpet on every kick. Also features the thick bumper found on our deluxe kicker (No. 1600-C), and internal power rods supporting the pin plate.

Order No.	Description	Parts per	Wt. Ea.
505	Knee Kicker	1	5.88 lbs.
525	Wide Knee Kicker	1	7 lbs.
1601-B*	Pin Plate	1	3 oz.
1505-K*	Gripper Inserts	3	2 oz.
1525-12**	Pin Plate	1	0.39 lbs.
1525-14**	Gripper Inserts	4	0.33 lbs.



- No. 525 Wide Kicker
- 5 $\frac{1}{4}$ " head
 - Extra row pins
 - 4 nap grips
 - Thick bumper



*Parts for No. 505 and No. 506. **Parts for No. 525



CRAIN

Seaming Cutters

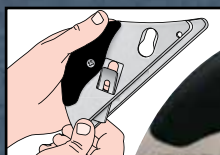

EASY
BLADE
REMOVAL

U.S. PAT. NO. 10,710,255



No. 301

NEW
LONGER
BLADE
REMOVAL
HOLES

No. 301 Cushion Back Cutter

Designed especially for trimming and cutting superdense $5/64$ " gauge foam or sponge-backed carpets. Double 30° angle blades cut either side of the row close and clean to help produce better seams. The long, slender front guide is beveled at the bottom, making it easy to stay in a row. Made from nickel-plated steel.

Trims close to the carpet pile on the right (Figure 1). On the left side, use the opposite blade (Figure 2). Close cuts on both seam edges produce better seams.

Order No.	Description	Weight	Blades
301	Cushion Back Cutter	8 oz.	306C, 308C, 309C

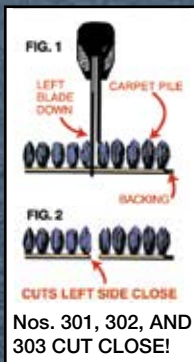

Nos. 301, 302, AND 303 CUT CLOSE!



No. 302
U.S. PAT. NO.
10,315,318 B2

No. 302 Cushion Lock Cutter

This cutter has a notched row guide that follows rows better, particularly on hydrashift and Berber carpets. The offset blade clamp allows fast blade changes without removal of the fastener. The 30° blade angle cuts cleanly.

Trims close to the carpet pile on the right (Figure 1). On the left side, use the opposite blade (Figure 2). Close cuts on both seam edges produce better seams.

Order No.	Description	Weight	Blades
302	Cushion Lock Cutter	8 oz.	306C, 308C, 309C

No. 302: NOTCHED ROW GUIDE
FAST OFFSET BLADE CLAMP

No. 303
"TRIPLE TIGHT"
THREE THUMB
SCREWS

U.S. PAT. NO.
8,567,075



SELF-CLEANING

No. 303 Loop Pile Cutter

This cutter has a base for cutting over pad or other carpet, and an adjustable throat that locks down on the row. Its 30° blade angle exposes more blade surface for smoother cutting. Now features three thumb screws that hold rigidly, and self-cleaning blade holders.

Order No.	Description	Weight	Blades
303	Loop Pile Cutter	8 oz.	306C, 308C, 309C

No. 290



3-in-1!
SEAM
CUTTER

No. 290 Seam Cutter Plus

This cutter excels on zigzag ("hydra-shift") carpets including commercial loop pile and Berbers! The blade runs directly behind the center row guide. This keeps the blade away from the offset yarns, preventing yarns from being sheared, which causes unsightly seams. The wide base keeps the blade perpendicular to the yarns, further reducing nap shear. The row guide can be retracted fully into the base for top cutting. The tool can also be used as a trimmer to precisely trim carpet up to Z-bar or vinyl molding.

Order No.	Description	Weight	Blades
290	Seam Cutter Plus	1.2 lb.	295C, 308C, 309C



ROW GUIDE
RETRACTS

TOP CUTTING

Z-BAR TRIMMER

VINYL
MOLDING
TRIMMER

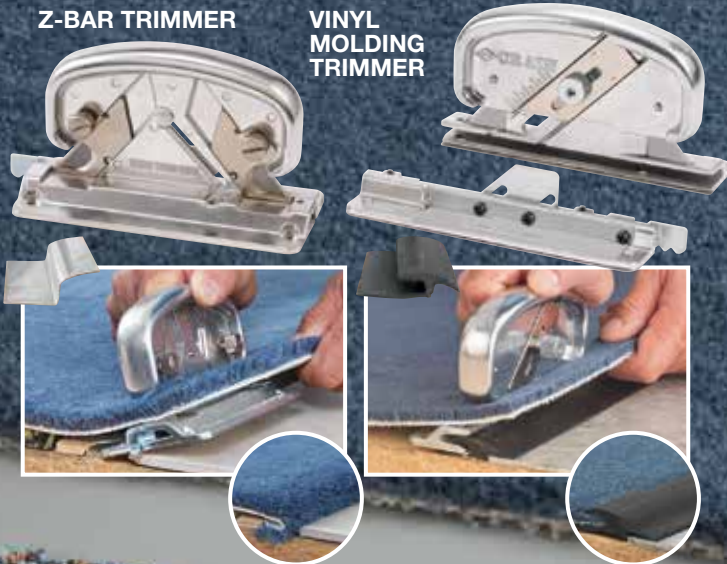

Straight Edges



No. 113



No. 113S



HIDES SEAMS
IN PATTERN OR
SCULPTURED
CARPETS



SERPENT EDGE

No. 119

No. 119S

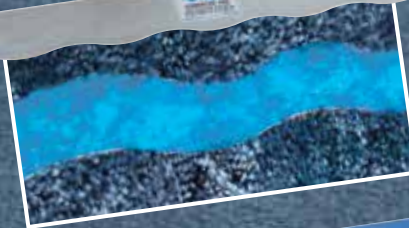

GUARANTEED
WITHIN .003"
OF PERFECTLY
STRAIGHT!

No. 334

SPRING STEEL
PROFESSIONAL
MODELS!

No. 334S

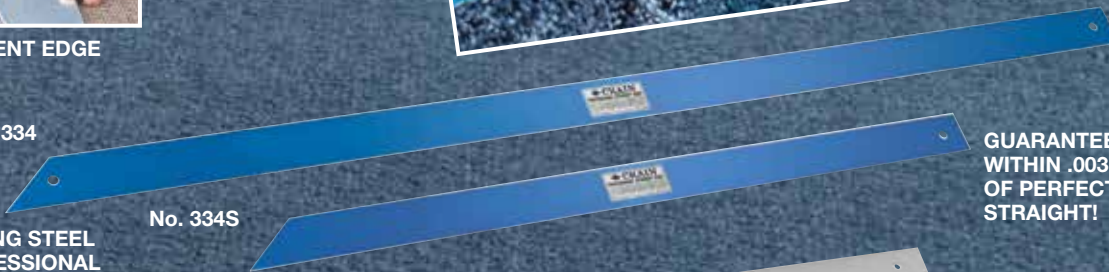

No. 535

No. 536

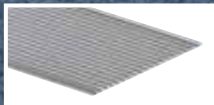

Nos. 535 & 536
SLIP-PROOF BOTTOM



No. 915

No. 912

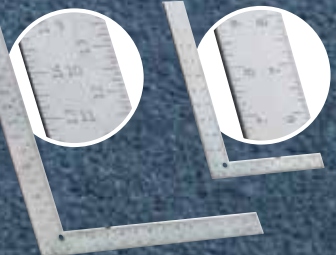

FOR DOORWAYS

FLEXIBLE
STRAIGHT
EDGES

No. 116

No. 117

No. 118



No. 113 & 113S Journeyman Straight Edges

These cold drawn steel straight edges are accurately ground and tested before shipment. Guaranteed to be straight within $\pm .005"$ at the time of sale. Both models have a 45° angle end and red painted surfaces to protect against rust.

Order No.	Dims.	Weight	Order No.	Dims.	Weight
113	6' x 3" x 1/8"	7 1/2 lbs.	113S	4' x 3" x 1/8"	4 1/2 lbs.

No. 119 & 119S Combination Edges

Now, the installer has the advantage of two tools in one. With one side of the tool straight and the other side a Serpentine Edge, it is usable for both resilient and carpet purposes.

Order No.	Length	Weight	Order No.	Length	Weight
119	75"	8 1/2 lbs.	119S	36"	4 1/3 lbs.

No. 334 & 334S Professional Straight Edges

Absolutely accurate and guaranteed to stay straight. These precision ground straight edges are made of special spring steel that will take the rough daily use that flooring tools get.

Order No.	Dims.	Weight	Order No.	Dims.	Weight
334	6' x 3" x 1/8"	6 1/2 lbs.	334S	4' x 3" x 1/8"	4 lbs.

No. 535 & 536 Carpet Straight Edges

These straight edges are made from hard extruded anodized aluminum, and have a hole at one end for hanging.

Order No.	Dims.	Weight	Order No.	Dims.	Weight
535	36" x 2 1/2" x 3/16"	1 1/4 lbs.	536	72" x 2 1/2" x 3/16"	2 1/2 lbs.

Crain Flexible Straight Edges

These handy spring steel straight edges are great for working in corners, doorways, and tight areas. The 45° angle end makes template work easier.

Order No.	Dimensions	Weight
116	18" x 2" x 1/32"	4 oz.
117	32" x 2" x 1/32"	6 oz.
118	39" x 2" x 1/32"	7 oz.

No. 912 & 915 Steel Square

The 912 has 1/16" graduations. The 915 has 1/8" graduations. Markings are permanently impressed in the steel. These squares are perfect for patterned sheet goods layout.

Order No.	Description	Body	Tongue	Width	Weight
912	Steel Square	12"	8"	1"	8 oz.
915	Steel Square	24"	16"	2"	1 1/2 lbs.



No. 627 Edge Sealing Tip
 • Convenient pulling action
 • Works in line of sight



Nos. 627 & 629



No. 204

No. 204 Glue Gun, Nozzles & Sticks

This 100 watt glue gun comes with both a carpet edge sealing tip and a conventional 1/8" nozzle. Carpet edges pre-sealed with hot melt dry quickly and resist fraying. During the seaming process, the hot iron reactivates the hot melt, allowing the edges to bond together to reduce seam peaking.

Order No.	Description	Watts	Weight
204	Edge Sealing Glue Gun	100	1 1/4 lbs.
201	10" Glue Sticks - 19 Stick Pk.	---	1 lbs.
202	4" Glue Sticks - 24 Stick Pk.	---	8 oz.
627	Carpet Edge Sealing Tip	---	1 oz.
629	1/8" Nozzle	---	1 oz.



No. 201 - 10"



No. 202 - 4"



No. 180

No. 180 Seam Squeezers

These powerful squeezing springs force cushion-back carpets together, producing an improved seam. The gripper pins hold in the nap and maintain an inward squeezing force. The inward pressure can be perfectly regulated as desired. Sold in pairs.

Order No.	Description	Weight
180	Seam Squeezers	1 lb./set

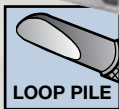

LOOP PILE



No. 365



CUT PILE

No. 365 Row Separator

This double-ended tool has a pointed end for cut pile with a wider conical surface behind the point. On tall cut pile, the narrow point penetrates deep within the row, while the wider conical surface spreads the tufts. The opposite end is beveled and rounded for spreading loops on loop pile and Berber carpets without snagging. This tool will effectively open and spread rows for reduced shearing of carpet nap. Machined from solid steel, and nickel plated.

Order No.	Description	Weight
365	Row Separator	2 1/2 oz.



No. 366



No. 367

No. 366 Commercial Row Finder No. 367 Residential Row Finder

The smooth, rounded notches of these ultra-straight spring steel row finders open rows in difficult carpets. The No. 366 has rounded ends that can easily enter the rows of Berber and loop pile commercial carpets without catching loops. The No. 367 has pointed ends that can more easily enter the rows of dense cut pile or plush carpets. Once these tools find a row, they can be moved back and forth in a sawing action to open the row. After use, a seam cutter is able to follow the row with reduced shearing of yarns.

Order No.	Description	Weight
366	Commercial Row Finder	1 1/4 oz.
367	Residential Row Finder	1 1/2 oz.



Carpet Shears

No. 187 Big Loop Nap Shears No. 190 Duckbill Napping Shears No. 496 8" Carpet Shears

No. 187 - These nap shears feature offset handles for level cutting, with big, vinyl-coated loops for ease of grip. The flat duckbill blade won't gouge in use. Made of forged and plated steel with coated handles.

No. 190 - Lightweight with smaller loops and duckbill for precise napping. Offset handles for level cutting. Flat duckbill won't gouge in use. Plated steel with vinyl coated handles.

No. 496 - An 8" long nap shear with longer blades. Nickel-plated with black offset handles for easy napping.

Order No.	Description	Length	Weight
187	Big Loop Nap Shears	7"	6 oz.
190	Duckbill Napping Shears	6"	5 oz.
496	8" Carpet Shears	8"	6 oz.



No. 187



No. 496
 8" NAPPING



No. 190



No. 905

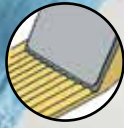

ANGLE-OUT BACK TIP



No. 905 Heat Bond Iron

The super low profile and ultra-narrow handle of this iron make it easier to get the seam together near the back of the iron. Dual indicator lights show both power-on and heating status. Self-cleaning base and 12' long HSJO cord are standard. The heavy-duty handle and riveted tray are highly durable. Available in grooved models only. Approximate heat range is 220° - 425°F. Runs at 800 watts. The No. 906 Kits comes with a steel case that can also hold a roll of tape, and a 25' 3-prong extension cord.

Order No.	Description	Weight Each
905	110 volt Iron	3 1/3 lbs.
905V	220 volt Iron	3 1/3 lbs.
906	110 volt Kit	15.3 lbs.
903	Universal Tray	8 oz.



**No. 905 ADVANTAGES:
DURABLE ROTATING CORD AND LOW PROFILE**

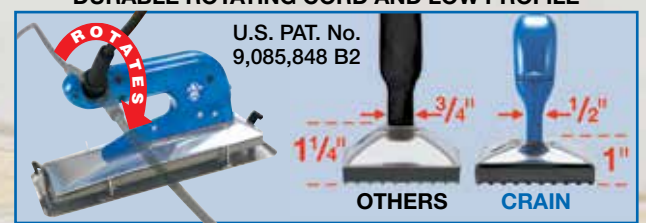

U.S. PAT. No. 9,085,848 B2

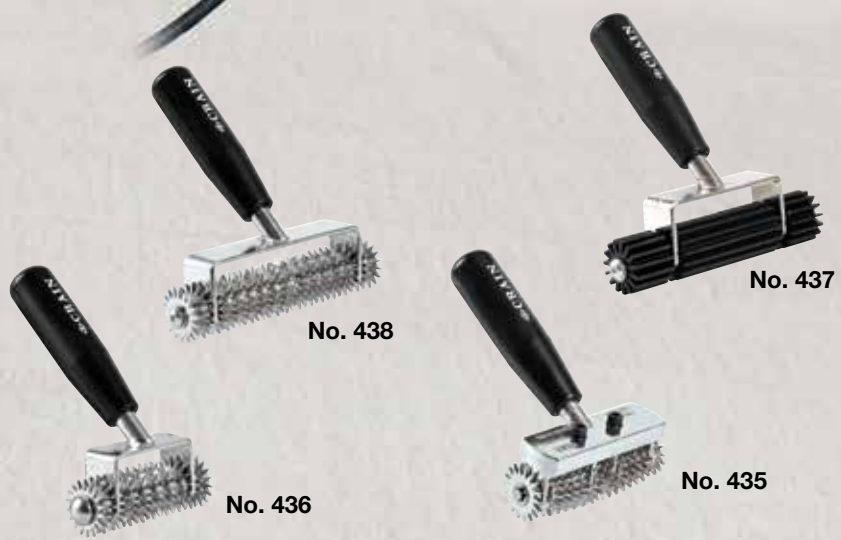

**No. 435 Flex Axle Roller
No. 436 Straight Axle Roller
No. 437 Bigfoot Roller
No. 438 Pro Roller**

The pivoting axle of the Flex Roller pulls seams together, while mixing the fibers for less visible seams. Nos. 435, 436, and 438 have spiked wheels that press through the pile to seal the carpet's back into the hot melt adhesives.

The No. 437 Bigfoot Roller is made with ribbed rollers, making it especially good for fine-denier saxony, plush, and velvet carpets, as it will not snag or untwist yarns.

Order No.	Description	Width	Weight
435	Flex Axle Roller	4"	10 oz.
436	Straight Axle Roller	4"	14 oz.
437	Bigfoot Roller	5 5/8"	15 oz.
438	Pro Roller	6"	14 oz.



No. 476 Carpet Tractor

Made with 3 rows of spaced 1 1/4" dia. spike wheels which flatten seams, reduce seam-peaking, and mix fibers for less visible seams. Durable construction and made in the U.S.A.

Order No.	Description	Size	Weight
476	Carpet Tractor	6" x 3" x 2"	2 lbs.



**No. 898
IRON COMBO
CASE ONLY**

TAPE & IRON NOT INCLUDED

No. 898 Iron Combo Case Only

This all steel case is designed for carrying carpet seaming irons. Features a hinged platform that adapts to hold 3" or 6" irons. Besides room for an iron, there's a partition for holding a roll of tape, plus space to loosely lay the iron's cord and an extension cord. Heavy-duty latch is lockable.

Order No.	Description	Weight Each
898	Iron Combo Case Only	8 lbs.



No. 245
U.S. PAT. NO.
6,421,923 B1

No. 245 Deluxe Carpet Trimmer

Features top-loading blade carriers, so blade changes are faster and easier. Wide open throat area provides smooth cutting action. Comes with six shims for height adjustment, and visual throat adjustment from the base for all kinds of carpet. Wall runner is treated with a non-skid material, and is angled outward for minimum wall contact.

Order No.	Description	Weight	Blades
245	Deluxe Carpet Trimmer	1½ lb.	184
1245-U	New Runner Pad, 245, 246	1/10 oz.	-



EASY BLADE CHANGE



OPEN THROAT FOR SMOOTH CUTTING

No. 246
U.S. PAT. NO.
7,356,932 B1
7,788,812 B2



No. 246 Carpet Trimmer

This new trimmer is similar to other popular models but with faster blade change and throat adjustment. When the wall runner is removed, the blades are easily accessible. The wall runner is easily reinserted by inserting a pointed edge into a relief in the shim and lifting. Throat adjustment sockets are stamped in every shim, eliminating the need for a separate part.

Order No.	Description	Weight	Blades
246	Carpet Trimmer	1.8 lb.	184



EASY BLADE CHANGE



EASY TO INSERT BLADE HOLDER



No. 247
MULTI Trims both carpet and vinyl



No. 145

No. 247 Multi-Purpose Wall Trimmer

A real time-saver when used to trim vinyl or carpet to fit walls! Slotted blades are used for carpet or vinyl trimming, while hook blades work best for carpet tiles. Comes with anti-friction boot for use on vinyl installations.



Order No.	Description	Weight	Blades
247	Wall Trimmer	2 lb.	306C, 308C, 996X

No. 145 Seam Adhesive Bottle

Used to seal the edges of carpets before seaming for stretched or glued-down jobs. Supplied with an applicator nozzle and snap-on cap for storage. Sealer not included.

Order No.	Description	Capacity	Weight
145	Seam Adhesive Bottle	8 oz.	1¼ oz.



Tucking Tools



Nos. 152B, 154 & 155 Stair Tools

Constructed of tough, durable, alloy steel to withstand hammering. The blades are ground to a perfect taper and won't cut the carpet. Nickel plated.

Order No.	Description	Width	Length	Weight
152B	Cushion Stair Tool	4"	8"	1 lb.
154	Narrow Stair Tool	2 7/8"	8"	1 lb.
155	Bent Stair Tool	3 1/2"	6"	1 lb.

No. 192 Turning Tool & No. 195 Carpet Awl

The bent-leg Turning Tool is used to turn carpet under "Z" Bar and to roll carpet into edge gully. The straight Carpet Awl has a heavy-duty high-carbon steel pointer that extends through the plastic handle for hammering.

Order No.	Description	Length	Weight
192	Turning Tool	6"	3 oz.
195	Carpet Awl	6 1/4"	3 oz.

Nos. 125 & 135 Chalk Lines & Chalk

No. 125 Irwin features easy sliding chalk door and tough aluminum construction. No. 135 Keson features 3-way gearing for fast retrieval. Refill chalk using No. 080 (white) or No. 080B (blue) chalk.

Order No.	Description	Line Length	Weight
125	Irwin Chalk Line	100'	8 oz.
135	Keson Chalk Box	100'	8 oz.
080	White Chalk Bottle		8 oz.
080B	Blue Chalk Bottle		8 oz.

No. 151 White Rubber Mallet

This non-marking white natural rubber mallet is perfect for malleting metal moldings. Durable hardwood handle.

Order No.	Description	Weight
151	White Rubber Mallet	20 oz.

No. 950 Professional Installers Tool Kit

This kit has the basic tools needed for carpet installation by the professional. The kit saves you money! The tools included in the kit are listed at the bottom of this page.

Order No.	Description	Weight
950	Professional Installers Tool Kit	29 lb.

Sewing Thread, Needles & Thimbles



NOTE: Polyester thread is less expensive; but can stretch, showing more of the seam.

Order No.	Description	Weight
769	Economy Polyester Thread	4 1/2 oz.
771	Natural Waxed Linen Thread	4 1/2 oz.
761	2 1/8" Long Needles (25 pack)	.05 lb.
762	3" Long Needles (25 pack)	.07 lb.
765	4" Curved Needles (12 pack)	.05 lb.
712	Thimble, Finger, Small #12	.01 lb.
713	Thimble, Finger, Medium #13	.01 lb.
714	Thimble, Finger, Large #14	.01 lb.
715	Thimble, Thumb, #00	.01 lb.



No. 950 Kit includes:		
No. 024 24" Tool Box	No. 157 Molding Lifter	No. 354 Tool Pouch
No. 080 White Chalk Refill	No. 187 Big Loop Nap Shears	No. 450 Deluxe Strip Cutter
No. 135 Chalk Box	No. 189 Hook Utility Knife	No. 505 Knee Kicker
No. 145 Seam Sealer Bottle	No. 245 Deluxe Wall Trimmer	No. 726 Pivoting Carpet Knife
No. 152B Stair Tool	No. 301 Cushion Back Cutter	
	No. 332 20 oz. Hammer	

U.S. PAT. NO.
7,966,734 B2

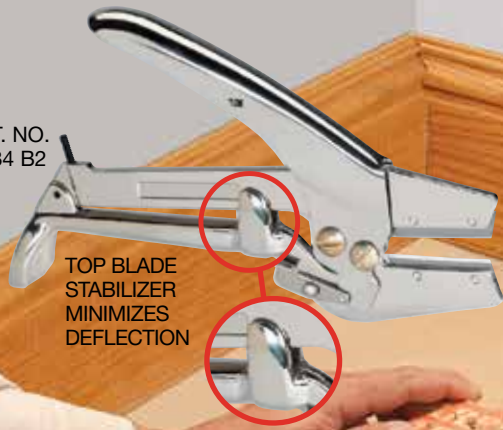

No. 450



ONE SNAP FOR ARCHITECTURAL

TOP BLADE STABILIZER MINIMIZES DEFLECTION

No. 450 Deluxe Strip Cutter

The new blade stabilizers on the No. 450 minimize deflection and provide increased cutting force. The extra long blades will cut a diagonal in regular strip or a straight cut in architectural. The handle features a blade storage area and comes complete with extra blades. Constructed of steel and nickel-plated to last a lifetime. Guaranteed 12 months.

Order No.	Description	Weight	Blades
450	Deluxe Strip Cutter	1 1/4 lb.	451

Hammers & Hatchets

Order No.	Description
332	ECONOMY HAMMER - Forged steel head is securely fastened to a fiberglass handle. Weight 20 oz.
296	VAUGHAN HALF-HATCHET - A multipurpose tool for cutting and hammering down tack strip. Features hardwood handle and sharpenable alloy steel blade. Weight 22 oz.

No. 172 Magnetic Tack Holder

This tool has a magnetic tip that holds the nail when it is difficult for fingers to do the job, particularly when nailing tackstrip with stubby nails. Made 5 1/2" long.

Order No.	Description	Weight
172	Magnetic Tack Holder	8 oz.

Nos. 362 & 363 Door Pin Tools

Both tools have a solid steel push pin on one end for pushing up the head of the door pin. The opposite forked end then fits under the head to lift it out. Forked end is tapered for insertion. The No. 363 also has a capture spring to keep the greasy pin from falling on the carpet.

Order No.	Description	Weight
362	Door Pin Tool	8 oz.
363	Deluxe Door Pin Tool	9 oz.

No. 166 Crain Magnetic Driving Bar

Features a forged alloy steel body with tapered nose and magnetic tip for nailing under toe-kicks and heaters. The vulcanized rubber handle absorbs vibration.

Order No.	Description	Weight
166	Magnetic Driving Bar	5 lb.

Crain Aluminum Drives

These fasteners are ideal for securing all types of tackless and metal mouldings to concrete, terrazzo, marble, slate, or ceramic floors. The semi-square body squeezes tight when hammered into a 1/8" drilled hole. The No. 078 oval head is for metal with counter-sunk screw holes.

Order No.	Description	Hole Size	Weight
078	1/8" x 7/8" Drives	1/8" x 7/8"	1 lb.
580	1/8" x 5/8" Drives	1/8" x 3/4"	1 lb.
780	1/8" x 7/8" Drives	1/8" x 1"	1 lb.
783	3/16" x 7/8" Drives	3/16" x 1"	1 lb.

No. 207 High Temp. Glue Gun 220W

No. 208 Acrylic 10" Glue Sticks

No. 209 Extra Open Time Glue Sticks

Acrylic glue sticks quickly bond tack strip, wood, metal trims and vinyl moldings to concrete, tile, stone or wood floors. They are a fast alternative to aluminum drives or contact cement. Extra open time glue sticks provide more time to position materials (approx. 3 min.) for gluing starter boards or long trim pieces. Use a high temperature glue gun such as the 220W Crain No. 207. The No. 207 has variable temperature control and includes carrying case.

Order No.	Description	Weight
207	High Temp. Glue Gun 220W	4 lb.
208	Acrylic 10" Glue Sticks (19 Pack)	1 lb.
209	Extra Open Time Glue Sticks (20 Pack)	1 lb.



No. 296



No. 332

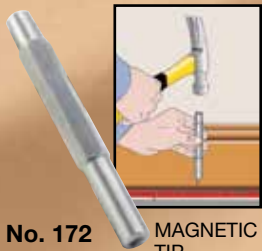

No. 172 MAGNETIC TIP

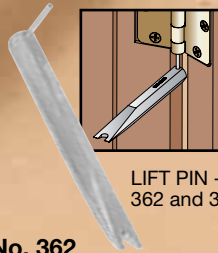

No. 362

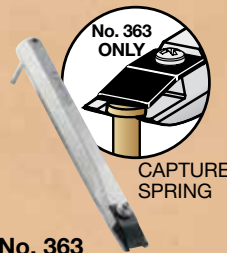

No. 363



No. 166

MAGNET TIP

Aluminum Drives

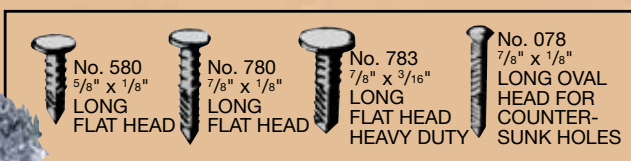

For solid carbide drill bits see page 30.



No. 207

No. 208 Acrylic Sticks - Tack strip



No. 209 Extra Open Time Sticks - Starter boards



Carpet Tackers



No. 635 Opto Power Tacker

The Opto Power Tacker has a ruggedized electronic control board with an optical sensor that fires in response to a tough sliding trigger. Eliminates delicate mechanical microswitches, which frequently required replacement. The long, slender nose parts yarns and gets down to the carpet's backing. The short height, narrow profile, and rounded cap allow stapling in tight areas. Powerful 11 AMP solenoid drives staples even into hardwoods. Precision jam-resistant magazine is rigidly mounted and opens with a release button. Once open, the staple channel is accessible to clear jams. Takes DuoFast® Nos. 5418 or 5415 staples, Shur-Fast (No. 619), or generics. DuoFast® is a registered trademark of the DuoFast® corporation.



No. 635



No. 619
9/16" LENGTH
"SHARP POINT"

Order No.	Description	Amps/Volts	Weight
635	Opto Power Tacker	11/115	5.9 lbs.
619	9/16" Shur-Fast Staples	---	1 1/8 lbs.
486	Safety Glasses	---	2 oz.



INCLUDES CASE AND STAPLE SAVER BOX

No. 518 Stair Claw

This tool provides a simple means of stretching stairs and forming carpet around the stair nosing. Hook the claw on the stair and pull the handle down. The pulling action of the gripper teeth stretches the carpet across the stair, while the bottom side tucks it up under the stair nose. Recesses in the bottom edge make for easy stapling. The stair claw makes a tough job easier!

Order No.	Description	Weight
518	Stair Claw	11 oz.



No. 518



No. 130 Staple Hammer and Staples

This proven tool is perfectly balanced for pad stapling. The rear-loading staple magazine holds 160 staples. Cleverly constructed, with only four moving parts. Built to take a beating.

Order No.	Description	Weight
130	Staple Hammer	2 lbs.
141C	3/8" Chisel Point (5000 pack)	1 lb.
142D	3/8" Divergent Point (5000 pack)	1 lb.



No. 130



No. 141C 3/8" LENGTH CHISEL
No. 142D 3/8" LENGTH DIVERGENT

No. 550 5000 Series Hammer Tacker No. 750 7500 Series Hammer Tacker

These economical hammer tackers feature simple bottom-loading magazines and all-steel staple driving mechanisms. The No. 550 takes 5000 series pad staples, and the No. 750 takes 7500 series pad staples.

Order No.	Description	Weight
550	5000 Hammer Tacker 1/2" Crown	2.16 lb.
750	7500 Hammer Tacker 15/32" Crown	2.23 lb.

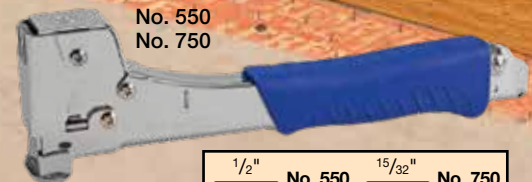

No. 550
No. 750

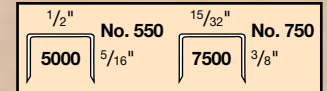

1/2" No. 550 5000 5/16"
15/32" No. 750 7500 3/8"

No. 147 Edge Binding Stapler

Ideal for binding area rugs or carpet samples. The staple guide adjusts the throat opening or can be removed altogether. The rear-loading magazine holds 150 staples. A well-designed tool, made to last a lifetime.

Order No.	Description	Weight
147	Edge Binding Stapler	1 lb.
148	5/16" Staples (5000)	1 lb.



No. 147

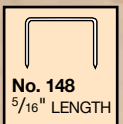

No. 148
5/16" LENGTH

No. 126 Staple Remover

The pinching action of this tool clamps the crown of the staple as the lever pulls it from the floor. Both staple legs are reliably removed, quickly and easily.

Order No.	Description	Weight
126	Staple Remover	8 oz.



No. 126

Staple Saver Boxes

These durable protective boxes for staple boxes are made from telescoping ratchet tubes. The No. 617 holds DuoFast® No. 5418 Electric Tacker Staples. The No. 618 holds DuoFast® No. 7512 Hammer Tacker Staples.

Order No.	Description	Weight
617	Staple Saver Box (5418)	2 oz.
618	Staple Saver Box (7512)	2 oz.



No. 617

No. 618

DuoFast® is a registered trademark of the DuoFast® corporation.



No. 725

No. 725 Deluxe Carpet Knife

Features a rear-loading blade magazine for quick access to extra blades. Dull blades are easily removed without dismantling, and new blades slide into place and lock down tight. Cast of aluminum, with a bright polished surface.



Order No.	Description	Weight	Blades
725	Deluxe Carpet Knife	4 oz.	306C, 308C, 309C



No. 726

No. 726 Pivoting Carpet Knife

This new knife features a thumb knob for quick opening and closing without a screwdriver. Pivots open for easy access to blade storage or replacement. Die-cast in aluminum. No blades are included along with this knife.

Order No.	Description	Weight	Blades
726	Pivoting Carpet Knife	4 oz.	306C, 308C, 309C



No. 733

No. 733 Extra-Grip Razor Knife

This carpet knife has a slim profile and heavy knurling on the body and up front for better grip and precision cutting. With a turn of the folding thumbscrew, it pivots open for blade storage. Blades are easily removed with a teeter-totter action. Blade clamp is magnetized for easy blade changes. Takes standard slotted razor blades.

Order No.	Description	Weight	Blades
733	Extra-Grip Razor Knife	4 oz.	306C, 308C, 309C



No. 217

No. 217 Hook Handle Razor Knife

The wide-contoured body and hook at the back creates comfort and permits a stronger grip. Pivots open for blade storage. Takes standard slotted razor blades.



Order No.	Description	Weight	Blades
217	Razor Knife	6 oz.	306C, 308C, 309C



No. 330

No. 330 Push-Button Carpet Knife

The fast-opening design of this knife requires only the press of a button! Full-size handle is knurled for sure grip. Takes standard slotted razor blades, with blade storage in the handle. Attractive red enamel finish.

Order No.	Description	Weight	Blades
330	Push-Button Carpet Knife	7 oz.	306C, 308C, 309C



No. 735

No. 735 Carpet Pad Knife

The unique blade angle of this knife shear-cuts cleanly, without shredding pad. Features a quick-opening thumb-knob and extra blade storage in the handle. Sturdily constructed, with a bright aluminum finish and a knurled anti-slip handle.



Order No.	Description	Weight	Blades
735	Carpet Pad Knife	4 oz.	306C, 308C, 309C

Carpet Knives



No. 728 Pocket Utility Knife

Takes any utility blade and has a durable blade holder that snaps closed and holds tight. The handle is contoured for comfort and has a special compartment for blade storage. Opens easily and locks rigidly for fast, forceful, and precise cutting.

Order No.	Description	Weight	Blades
728	Pocket Utility Knife	8 oz.	295C



No. 175 Tuck Knife

This knife has a multi-purpose steel blade to tuck carpet near fragile tiles or toilets, hook edge for heavy cutting, front scraper edge with a notch to remove door pins, and a flat head screwdriver for Crain scraper screws. Other end has steel tapping insert. Blades are replaceable.

Order No.	Description	Weight	Blades
175	Tuck Knife	5 oz.	177



No. 103 Long Hook Knife

A better knife in every way! The 3" long blade is absolutely sharp and holds its edge after others would be dull. Also features a truly comfortable contoured handle.

Order No.	Description	Weight
103	Long Hook Knife	4 oz.



Sharpening Stones

No. 910 Sharpening Stone

No. 930 Laminated Sharpening Stone

These silicone carbide sharpening stones are especially designed for curved carpet and linoleum knives. The No. 930 Laminated Stone is two kinds in one – laminated 50/50 with fine on one side, medium on the other.

Order No.	Description	Weight
910	Sharpening Stone	8 oz.
930	Laminated Sharpening Stone	1 lb.

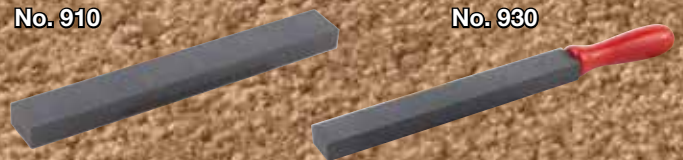

No. 174 Instant Repair Tool

An inexpensive tool for removing stains in carpeting. It has four blades and a pivot pin that cuts a 3" diameter hole. Made of durable aluminum.

Order No.	Description	Weight	Blades
174	Instant Repair Tool	2 oz.	1174-A



CIRCLE CUTTER

Great for making circular plugs for repairs!

No. 300 Loop Pile Cutter

Now takes utility, slotted razor, or Crain No. 300Y blades. With utility or 300Y blades, it cuts from the backing and prevents shearing of yarns. Metal springs keep carpet from raising up.

Order No.	Description	Weight	Blades
300	Loop Pile Cutter	8 oz.	295C, 300Y, 308C



No. 304 Versa-Cutter

Our most durable and versatile cutter takes utility blades, slotted razor blades, or Crain 300Y Loop Pile Blades. When used with utility or Crain 300Y blades, this cutter cuts smoothly from the carpet's backing, and will not shear yarns. Also features a steel foot plate for use on concrete.



Order No.	Description	Weight	Blades
304	Versa-Cutter	8 oz.	295C, 300Y, 308C



NEW!

No. 300 & No. 304 BOTH NOW TAKE:





CRAIN

Power Stripper



No. 710
U.S. PAT. NOS.:
10,316,529 B2
10,640,997

Spud blade for tile and wood

Includes blades: Multi-Purpose

Vinyl

Razor Adaptor



Strip VCT



Strip Vinyl



Strip Tile



Strip Wood



Low Blade Angle

Strip Carpet



Strip Glue

No. 710 Power Stripper

The Crain Power Stripper features new "Power Channel" construction designed to force the blade forward with more focused energy. The oscillating cam action of the one horsepower motor is channeled straight ahead using steel channels and ball bearings. The blade carrier forms an ultra-low blade angle allowing the blade to get beneath the material to be removed. Comes with a new heavy-duty 5 1/2" long x 3 3/8" wide x 1/4" thick "Spud-Blade" (No. 711) for light tile and wood removal. Also includes No. 701 4" x 6" Vinyl Blade, No. 705 3" x 10" Multi-Purpose Blade, No. 717 Stripper Razor Blade Adaptor, and 35 lb. weight. A variety of blades are available for different jobsite conditions and different types of flooring. See the table below.

Order No.	Description	Weight
710	Power Stripper	145 lbs.

Fast Blade Angle Adjustment:



Spring Loaded

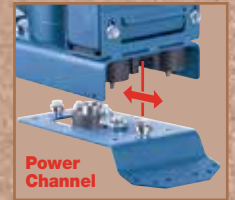

Power Channel

No. 718 Power Scraper

This lighter machine has a 1/2 horsepower motor and power channel construction enabling it to take up heavy adhesive residue, vinyl or VCT. Front-mounted 40° angled telescoping handle puts extra force behind, and extra pressure down on the stripper blade. The machine is highly maneuverable and collapses quickly for easy carrying. Comes with a No. 701 4" x 6" Vinyl Blade, No. 705 3" x 10" Multi-Purpose Blade, No. 717 Stripper Razor Blade Adaptor, and narrow No. 719 3 1/2" x 3 3/4" Thin Spud Blade for tough take ups. Power channel construction forces the blade forward with more focused energy. The all-steel frame and handle provides rigidity and durability. A variety of blades are available. See table below of Stripper Machine Blades.

Order No.	Description	Weight
718	Power Scraper	58 lbs.

Stripper Machine Blades

These blades are for use with the discontinued Crain No. 700 Bearcat Stripper, No. 710 Power Stripper and No. 718 Power Scraper. "D" signifies double-edge.

Order No.	Description	Weight
701	4" x 6" Vinyl Blade	6 oz.
702D	4" x 6" D. E. Vinyl Blade	6 oz.
703	5" x 6" Carpet Blade	8 oz.
704D	5" x 6" D. E. Carpet Blade	8 oz.
705	3" x 10" Multi-Purpose Blade	8 oz.
706D	3" x 10" D. E. Multi-Purp. Blade	8 oz.
707	3" x 16" Wide Cleaner Blade	13 oz.
708	5" x 16" Wide Cleaner Blade	1 lb.
711	5 1/2" x 3 3/8" Thick Spud Blade	1 lb.
717	Stripper Razor Blade Adaptor	1 lb.
719	3 1/2" x 3 3/4" Thin Spud Blade	5 oz.



Collapse & carry!



Power Channel



NEW No. 718

Thin Spud

Includes blades: Multi-Purpose

Vinyl

Razor Adaptor

Strip Glue

Strip VCT

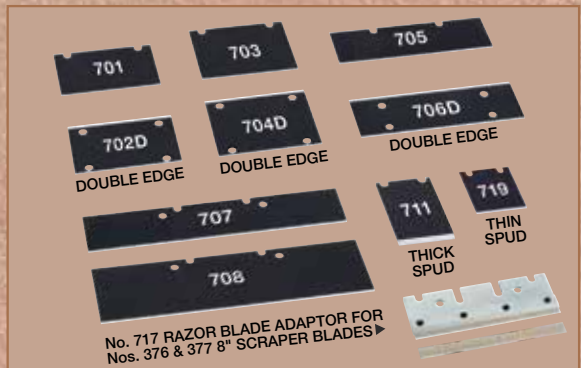

No. 717 RAZOR BLADE ADAPTOR FOR Nos. 376 & 377 8" SCRAPER BLADES

Tear-out Tools



No. 265 Stand-Up Cutter

Used to slice glue-down carpet into strips, or for rough cutting of carpet off the roll. Features a sharp, hardened point that lifts the carpet into the blade. The point rides on the subfloor, pre-cutting the carpet and extending blade life. The handle is adjustable in length and double-locks for safety. Uses hook or utility blades.

Order No.	Description	Weight	Blades
265	Stand-Up Cutter	3 lbs.	295C, 996X
266	Replacement Point	2 oz.	-----

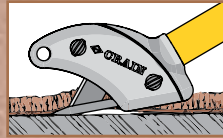

POINT LIFTS CARPET TO THE BLADE

No. 265

Nos. 375 & 375S Big Scraper & Blades

These tools feature a wide, heavy-duty replaceable blade, and a twist-lock adjustable telescoping handle. Two models are available, for standing or kneeling. The stand-up model saves a lot of crawling. Great for stand-up floor scraping, but not for heavy-duty prying.

Order	Description	Handle Length	Min.	Max.	Wt.	Blades
375	Big Scraper	39"	59"	4 lbs.	376, 377	
375S	Short Big Scraper	19"	26"	2 lbs.	376, 377	



No. 350 & 360 Pro Strippers

These top quality hand strippers have heavy-duty 3 screw blade holders, hardened blade screws, and thick round-ended handle grips that fit the palm. The No. 350 has a 12" handle, and No. 360 has a 20" handle for more reach and room for gripping on the handle.

Order No.	Description	Length	Weight
350	Floor Stripper	12"	8 oz.
360	Pro Stripper	20"	12 oz.
351	Blades, vial of 10		1 oz.
351C	Blades, disp. box of 100		1 lb.



No. 350

No. 360

No. 390

No. 375S

No. 375

No. 390 Inertial Scraper

This new scraper helps you plow through the toughest removal jobs with less effort. Its metal handle is weighted to produce inertia, and has rounded edges to prevent sore palms. Comes with one 5" blade.

Order No.	Description	Weight
390	Inertial Scraper	1 ³ / ₄ lbs.
391	Inertial Scraper Blades (10)	10 oz.



No. 844

No. 844 Pulling Claw

Grab an edge of some glued down carpet and pull away with this compound leverage tool! The spring-loaded jaw opens automatically for insertion of carpet. The harder you pull, the harder the roller-activated upper jaw clamps down on the lower jaw. The large contoured handle provides a good gripping surface.

Order No.	Description	Weight
844	Pulling Claw	2 lbs.

No. 230 Deluxe Floor Scraper

Our best hand floor scraper, this tool features a 2" wide sharp tool steel blade that shaves-up all types of floor coverings on concrete or wood subfloors.

Order No.	Description	Weight
230	Deluxe Floor Scraper	13 lbs.
231	Replacement Blade	6 ¹ / ₂ oz.
232	3" Replacement Blade	10 oz.



No. 666

No. 337

No. 230

No. 666 Dust Pan

Made from one piece of rugged 20 gauge steel with corrugated ribs for stiffness. Lip is 12" wide with a beveled edge.

Order No.	Description	Weight
666	Dust Pan	1 ¹ / ₄ lbs.

No. 337 Duster Brush

This quality wood-handle brush is made from long-lasting blended horsehair. Size 2¹/₂" x 14" overall, 8" blade.

Order No.	Description	Weight
337	Duster Brush	1 lb.



No. 232

No. 231

CRAIN

Vinyl Tile Cutters



No. 008

No. 001

NEW!

**BLADE HEIGHT
 ADJUSTMENT
 KNOBS**

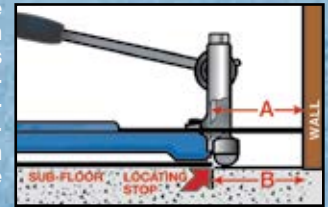

No. 001 Model "A" Tile Cutter

The Crain 12" cutter provides the accuracy demanded by professionals. The straightness of cut is factory-calibrated to +/- .005" prior to shipment, which is essential for precisely matching edges in pattern work. The cutter also has a locating stop for repeat cuts at the wall. When the tile to be cut is placed in the cutter, dim. A equals dim. B. The built-in low-profile blade height adjustment knobs are fast-activating. Comes with compact carrying case and instructions.

Order No.	Description	Weight
001	Model "A" Tile Cutter	23 lbs.

No. 008 18" Vinyl Special Tile Cutter

This cutter is built to cut up to 18" resilient tiles straight, or 12" tiles diagonally. Comes with both diagonal and straight tile guides. Features a locating stop for repeat cuts at the wall (see No. 001 above), and built-in low-profile blade height adjustment knobs. The steel reinforced blade holder and heavy-duty base ensure straight and accurate cutting.

Order No.	Description	Weight
008	18" Vinyl Special Cutter	31 lbs.

No. 310 Dividers

This popular double-needle design features a rounded radius arm and oversized thumb knob for smooth and secure adjustment. Pins are replaceable (No. 311). This is a simple design that many vinyl installers prefer.

Order No.	Description	Rep. Needle	Weight
310	Dividers	No. 311	6½ oz.

No. 382 Double-Needle Dividers

This tool features a smaller, 4" overall size that fits into the palm of the user's hand, and double needles for completely versatile scribing. It has a fixed bent leg and a dismountable straight leg for pencil scribing. The locking knob is easily tightened or loosened without a screwdriver. Spans 6".

Order No.	Description	Rep. Needle	Weight
382	Double-Needle Dividers	No. 129	2 oz.

No. 380 Deluxe Dividers

Styled similar to the Wilkee, these dividers are the industry standard. Constructed of forged steel and plated. Features a bent leg and a removable pin vise with a knurled tightening cap. The 6" legs expand to scribe up to 14" circles.

Order No.	Description	Rep. Needle	Weight
380	Deluxe Dividers	No. 129	4 oz.



No. 382

No. 310

No. 380

Trim Line® Vinyl Corners:

OUTSIDE
 SILVER - #270
 GOLD - #272



COMPLETE OUTSIDE CORNER

INSIDE
 SILVER - #271
 GOLD - #273



COMPLETE INSIDE CORNER



SILVER GOLD

INSIDE OUTSIDE INSIDE OUTSIDE

COMES WITH APPLICATOR

Trim Line Vinyl Corners

Trim Line corners cover up problems at covered inside or outside corners. Great for repairs. Sold by each in standard pack of 25 corners, in silver or gold.

Order No.	Description	Weight
270	Outside Silver Corner, Each	0.14 oz.
271	Inside Silver Corner, Each	0.14 oz.
272	Outside Gold Corner, Each	0.14 oz.
273	Inside Gold Corner, Each	0.14 oz.

Vinyl Rollers



Crain Seam Rollers

These resilient seam rollers have a single-arm design that lets you work close to the wall. The 2" diameter polished steel roller rides on a ball bearing race. The heavy-duty ferrule and arm bracket are plated to prevent rust.

The rollers come in two different handle lengths to suit your preference. The No. 348 & No. 349 rollers feature 9" wood handles. The No. 348S & 349S rollers have 6" wood handles.

Order

No.	Description	Wt.	Width	Dia.	Handle
348	Square Edge Roller	2 lbs.	2"	2"	9"
348S	Square Edge Roller	2 lbs.	2"	2"	6"
349	Round Edge Roller	2 lbs.	2"	2"	9"
349S	Round Edge Roller	2 lbs.	2"	2"	6"



No. 333 Crain Extension Wall Roller

A newly redesigned roller, much improved to make the work easier. The raised handle allows firm control with less effort. The tri-sectional rollers total 7 1/2" wide. The new twist-lock adjustable handle telescopes from 17" to 27". The bright nickel-plated parts won't rust.

Order No.	Description	Weight
333	Extension Wall Roller	3 lbs.

No. 346 "J" Roller

This hand roller is designed especially for use by plastic laminate installers. The 14" aluminum handle is designed to place the necessary pressure over the roller, with minimum effort. The 3" wide, solid, non-marking roller is recessed on the end to permit rolling near walls or back splashes.

Order No.	Description	Weight
346	"J" Roller	8 oz.



Nos. 075 & 076 Vinyl Rollers

Crain No. 075 (75 lb.) and No. 076 (100 lb.) rollers now have zinc plated roller sections to help prevent rust, and come with a protective wheeie case (No. 074 - sold separately). Constructed of solid steel to provide a lifetime of trouble-free service. All models have rollers with smooth surfaces and rounded corners to protect flooring materials from indentations. Each roller section "floats" independently on the axle to automatically compensate for subfloor irregularities. The end roller sections are recessed to inset the axle, preventing wall scuffing. The yoke has a detachable handle so that both may be carried separately.

Order No.	Desc.	Wt.	Dia.	Width	Height
075	Vinyl Roller	75 lbs.	4 1/2"	16"	38"
076	Vinyl Roller	100 lbs.	5 1/2"	16"	38"
074	Roller Case	8 lbs.	---	---	---

NEW!
75 lb. & 100 lb. rollers now come in carrying case with wheels



No. 143 Disp. Adhesive Syringe

Solve air bubble problems fast with this disposable adhesive syringe and needle. The 2" hollow point tapered needle delivers adhesive right to the problem spot with an invisible puncture. State law prohibits sale in these states:

Connecticut, Maryland, New Jersey, Delaware, Massachusetts, New York, Maine, New Hampshire, Rhode Island.

Order No.	Description	Weight
143	Adhesive Syringe & Needle	4 oz.



No. 074
Vinyl Roller
Case w/Wheels



SOLD SEPARATELY - HOLDS
ROBERTS AND GUNDLACH
U.S. PATENT
#7,188,724 B1
#7,571,806

No. 075 - 75 lb.
No. 076 - 100 lb.

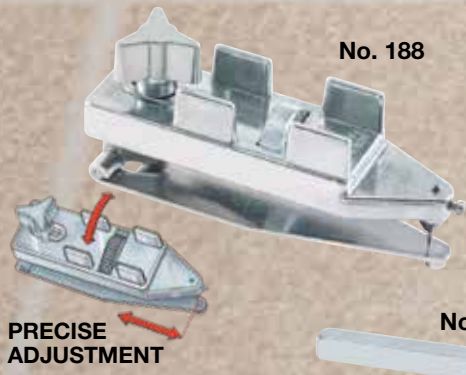

No. 188 Crain Hinge Scriber

At last – an improved seam scriber for linoleum, sheet vinyl, and cushion flooring materials. The tool features a heavy-duty hinged guide, with a threaded adjustment relative to the needle. The 3-arm knob clamps tightly after the adjustment. The tool is comfortable to the grip, giving the user good control. Uses No. 129 Scriber Needles.

Order No.	Description	Weight
188	Hinge Scriber	4 oz.

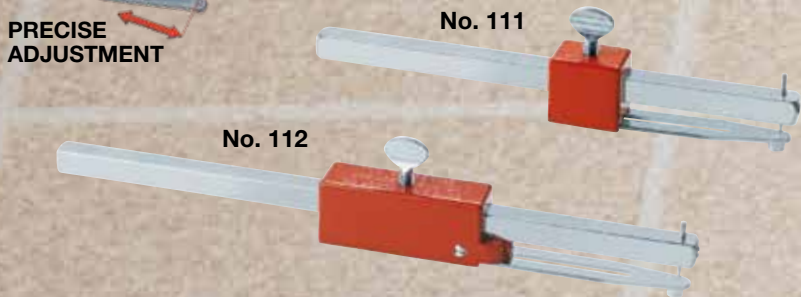

No. 111 & 112 Scribes

These versatile tools feature the original famous Airway quality design and construction – a heavy die-cast housing, with a sturdy precision-fitting plated steel bar. No. 111 features a 6" bar. No. 112 features an 8" bar with an extra needle hole in the housing for circle scribing. Both come with one needle, and use No. 129 Scriber Needles.

Order No.	Description	Length	Weight
111	Scriber	6"	4 oz.
112	Scriber	8"	8 oz.



No. 370 Recess Scriber

This scriber has a two part brass thumb knob. The top portion adjusts pin height for material thickness, while the bottom sets the scribing depth in the slot. No screwdrivers needed! Pins are replaceable (No. 371).

Order No.	Description	Weight
370	Recess Scriber	3 oz.

No. 372 18" Scribing Tool

This tool accurately scribes widths from 2" to 16". The round tip on the nose guides against the edge of the vinyl or along walls when needed. Replacement pin: No. 371

Order No.	Description	Weight
372	18" Scribing Tool	4 oz.



No. 340 Selvage Trimmer

Trims the factory selvage, so the sheet can be accurately scribed and seamed. Insert the selvage in the slot and pull. The replaceable "V-shaped" blades ensure accuracy. (For blades, order No. 341 - 1 pack or No. 342 - 3 pack.)

Order No.	Description	Weight
340	Selvage Trimmer	10½ oz.

No. 320 Vinyl Wall Trimmer

This tool accurately trims sheetgoods net to the wall. Adjustable front and rear guides provide precise control. The front bar holds that material in position against the wall. The rear guide keeps the trimmer running parallel with the wall for smooth trimming action. Comes with one hook blade. Blades: No. 321 Vinyl Wall Trimmer Blades (3).

Order No.	Description	Weight
320	Vinyl Wall Trimmer	8 oz.



No. 194 Crain Outside Corner Scriber

Designed for easy and accurate scribing of outside cove corners. Polished metal construction. Comes with one needle. Uses No. 128 Needles.

Order No.	Description	Weight
194	Outside Corner Scriber	3 oz.

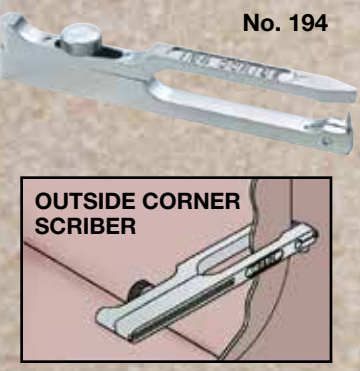

No. 110 Inside Cove Corner Kit

This 3-piece tool kit really simplifies inside cove corner installations. The kit consists of a cove template, a pin vise, a special cove scriber, and detailed instructions. The system is foolproof, once mastered.

Order No.	Description	Weight
110	Inside Cove Corner Kit	8 oz.

Vinyl Knives



No. 102 Crain Combination Knife

This fine knife combines both pointed and hook blades, making it two tools in one. The handy hook cuts both carpet and sheet goods, and is easily sharpened. The contoured handle fits perfectly in your hand.

Order No.	Description	Weight
102	Crain Combination Knife	4 oz.



No. 102

No. 732 Extra-Grip Utility Knife

Added knurling and contours up front provide better grip for precise cutting. With a turn of a thumbscrew, it pivots open for blade storage. Blades are easily removed with teeter-totter action. Blade clamp is magnetized for easy changes.

Order No.	Description	Weight	Blades
732	Utility Knife	3 oz.	295C, 996X



No. 732

No. 189 Hook Handle Utility Knife

Wider contoured body and hook at the back allows your fingers to pull with increased power. Great on vinyl when used with hook blades, and takes all utility blades as well.

Order No.	Description	Weight	Blades
189	Hook Handle Utility Knife	4 oz.	295C, 996X



No. 189

No. 727 Delphin Knife

Features a unique hinged body joint and a large tightening thumb knob for easy opening and blade changing of both hook and utility-type blades. The contoured body shape enhances gripping. Extra blades are stored in the handle.

Order No.	Description	Weight	Blades
727	Delphin Knife	4 oz.	295C, 996X



No. 727

Dexter Linoleum & Vinyl Knives

The No. 060 Dexter Linoleum Knife has a blade ground especially for cutting linoleum, while the No. 063 is ground for cutting vinyl. The knives have a resharpenable, high-carbon 2½" deep hook blade. The wide blade body on these knives provides stiffness and control, while the sharp point improves accuracy. The wood handle is contoured for firm grip. These are fixed riveted blade and handle combinations.

Order No.	Dexter No. & Description	Weight
060	X752 ½ Linoleum Knife	3 oz.
063	VX752 ½ Vinyl Knife	3 oz.



Nos. 060 & 063

No. 005 Ward Handle

This knife for vinyl installation takes specialty blades that can adjust to a wide array of angles for difficult materials. With the No. 026A hook blade, it cleanly cuts felt back vinyl.

Order No.	Description	Package
005	Ward Handle	1
012	Standard Blade	12
013	Heavy Blade	12

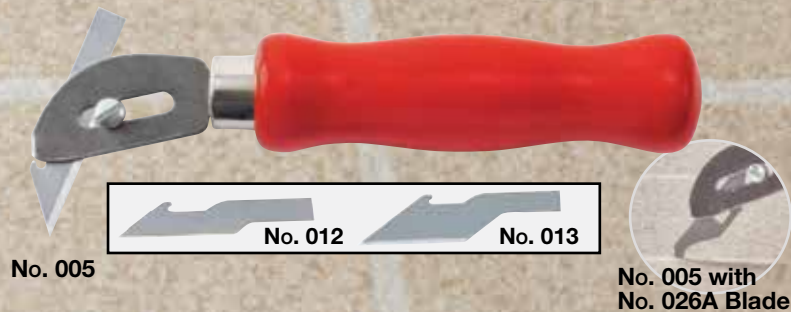

No. 005

No. 012

No. 013

No. 005 with No. 026A Blade

No. 006 Airway Knife

This knife is specially contoured for comfort. Made of smooth die-cast aluminum with close-fitting tolerances. One screw loosens the case for easy blade changing.

Order No.	Description	Weight
006	Airway Knife	6 oz.
025A	Airway St. Blades, 12/pkg.	1 oz.
026A	Airway Hook Blades, 12/pkg.	1 oz.



No. 006

No. 026A



SIMPLE DEPTH ADJUSTMENT



FLOOR FOLLOWING WHEEL

No. 968 Floor Following Groover
No. 971 12 Tooth Carbide Blade
No. 972 Diamond Groover Blade

This tool tracks in the seamline to cut a trapezoidal groove even when floors are not level, up to 1/8" of variation over one foot of seamline. The floor following wheel rides on the floor to raise or lower the blade in response to variation. A spring-loaded floor following dust shroud improves dust control. Includes a 12 tooth 130mm carbide-tipped blade (No. 971), and carrying case. Diamond grit blade for metal-impregnated safety floors is available (No. 972). 110VAC 9A No load RPM 12,000. Max. groove depth 3.5mm.

Order No.	Description	Weight
968	Floor Following Power Groover	20½ lbs.
971	12 Tooth Carbide Blade	8 oz.
972	Diamond Groover Blade	1 lb. 1 oz.

No. 969 Heat Weld Gun
No. 962 Round Welding Tip
No. 963 Pencil-Tip Nozzle
No. 979 Universal Welding Tip

This electronic gun features precise heat, and comes with a pencil-tip nozzle (No. 963), round tip (No. 962) and carrying case. The nozzle and tip are standard size to fit other common guns, and are sold separately. The No. 979 is a universal tip for Crain No. 960, 969 or No. 980 heat guns, and adjusts for welding 3mm or 5mm round threads.

Order No.	Description	Weight
969	Heat Weld Gun	6½ lbs.
962	Round Welding Tip	1 oz.
963	Pencil-Tip Nozzle	3 oz.
979	Universal Welding Tip	4 oz.

No. 985 Quarter Moon Knife
No. 986 Trim Guide

Used for trimming the excess vinyl weld thread flush to the floor's surface, after the weld has cooled. The knife's flexible top edge is razor-sharp. Pushed against the weld excess, this curved edge shaves the weld flush. This may be done in steps, first using the trim guide, and then making a final pass over the seam with the knife only.

Order No.	Description	Weight
985	Quarter Moon Knife	2 oz.
986	Trim Guide	1 oz.

No. 987 Pressure Roller

Used to roll the vinyl welding thread tightly into the groove in awkward areas, such as up covered walls. The handle is drilled through, so the welding thread passes through it instead of the welder tip for this usage.

Order No.	Description	Weight
987	Pressure Roller	2 oz.

No. 988 Vinyl Welding Kit

Comes with No. 968 Floor Following Power Groover, No. 969 Heat Weld Gun (with No. 963 Pencil-Tip Nozzle and No. 962 Round Welding Tip), No. 340 Salvage Trimmer, No. 370 Scribe, No. 965 Skiving Knife, No. 955 Hand Groover, No. 189 Utility Knife, No. 349 Round Edge Seam Roller, cleaning brushes with stainless steel bristles, metal case, and instructions.

Order No.	Description	Weight
988	Vinyl Welding Kit	35 lbs.

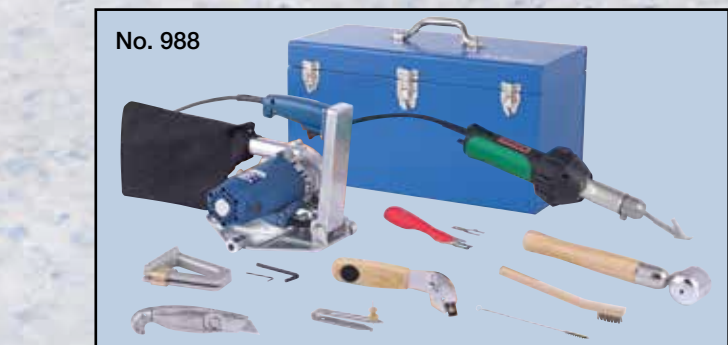

Other Vinyl Tools



No. 965 Skiving Knife

This knife for trimming heat weld rod flush at the seams has a sharp blade that's replaceable. Eliminates difficult resharping of quarter moon knives. Cuts in two passes with the built-in trim guide. Take the first pass with the guide under the blade, then pivot out on the second pass. The flexible blade and trim guide won't gouge high spots.

Order No.	Description	Weight
965	Skiving Knife w/Replaceable Blade	7 oz.
966	Replacement Blade Only	1/4 oz.
967	Replacement Blades (5) pack	1 1/4 oz.

FLEXIBLE BLADE AND TRIM GUIDE
WON'T GOUGE HIGH SPOTS!



FIRST PASS
GUIDE UNDER



SECOND PASS
GUIDE PIVOTED

No. 965
BUILT-IN
PIVOTING
TRIM
GUIDE



No. 966

No. 955 Pull Hand Groover

A pull hand groover improves control and permits faster work. Adjustable fin tracks in the seam to control grooving depth. Useful for starter cuts for a power groover, in tight areas, or when floors aren't level. Comes with 3 blades.

Order No.	Description	Weight
955	Pull Hand Groover	6 oz.
956	Pull Hand Groover Blades (3)	1/2 oz.



No. 955



No. 956

No. 745 & 995 Deluxe Heat Guns

These flameless heat guns come in 750° or 1000° models. The high-speed fan blows hot air, while the adjustable intake shuttle adjusts temperature. A 3-way switch provides hot, cold, or off. Elements are easily replaceable. Both models come with an adjustable stand and carrying case.

No.	Description	Amps	Max°F	Weight	Element
745	Deluxe Heat Gun	14	750°	4.5 lbs.	1745-030
995	Deluxe Heat Gun	14	1000°	4.5 lbs.	1995-450
745K	Multi-Purpose Case			4.0 lbs.	



No. 751

No. 745
No. 995



COMES WITH
FREE CASE

No. 751 Thriftline Heat Blo Gun

This economy gun heats material with temperatures adjustable from 300° to 1000°F. Features a 6' heat-resistant cord and a switch for hot or cold air. Stands upright to avoid burning the floor. The element is controlled by thermocouple for precise heat control.

Order No.	Description	Volts	Watts	Max°F	Weight
751	Thriftline Heat Gun	110	1200	1,000°F	2 lbs.

No. 730 Utility Knife

This classic knife features an easy-to-grasp thumb knob for quick opening without a screwdriver, and ample leverage for tightening securely. It is die cast of lightweight aluminum, with a knurled, anti-slip, brightly polished surface. The knife pivots open to store extra blades inside the knife body. Takes standard heavy-duty utility and hook blades.

Order No.	Description	Weight	Blades
730	Utility Knife	4 oz.	295C, 996X

No. 730



No. 128 & 129 Scriber Needles

These sharp, high carbon steel needles are for common scribers and dividers. Come packaged 50 per pack.

No.	Size	For use in Tool
128	.058 X 9/16"	194 Outside Corner Scriber ONLY!
129	.063 X 7/8"	109 110 111 112 188 240 355 380 382



No. 128



No. 129

No. 109



No. 109 Pin Vise

Features a hexagonal chuck that holds No. 129 needles. Perfect for scoring tile or linoleum pattern layouts.

Order No.	Description	Weight
109	Pin Vise	1 oz.

Blades for Discontinued Crain Saws

No. 803 & 804 for use on discontinued Nos. 800 & 810 Super Saws. No. 803 is best used for wood that splinters. No. 804 is best for general undercutting. The No. 788 is for use with Crain No. 785 & 795 Toe-Kick Saws only.

Order No.	Description	Weight	Teeth
788	2 3/4" Toe-Kick Saw Blade	2 oz.	16
803	Combination Blade	10 oz.	100
804	Carbide Blade	10 oz.	40



No. 788 - for
Nos. 785 & 795
Saws ONLY:



No. 803



No. 804

For Nos. 800 and 810 ONLY:



NEW

**No. 565
Bullnose
Adaptor
for stairs**

No. 565

No. 565 18' Strap Clamp No. 566 Bullnose Adaptor

Clamps and holds plank flooring across widths up to 18 feet. Strap coils inside the housing, out of the way of the work. Long base works under toe spaces. Available Bullnose Adaptor clamps across stair treads.

Order No.	Description	Weight
565	18' Strap Clamp	2.2 lbs.
566	Bullnose Adaptor	4 oz.



Bullnose Adaptor
Sold separately



No. 564

No. 564 Variable Wall Spacer

Improved with wider, heavier base and larger, ergonomic twist-knob that will accept an Allen wrench on the back side. Use to space planks from the wall or clamp and press the butt joints.



Order No.	Description	Weight
564	Variable Wall Spacer	1 lb.



No. 673 14" Wood Cutter

Cuts plank flooring up to 3/4" thick, including a variety of solid hardwood, engineered wood, laminate, and LVP planks. Built-in wheels allow it to be easily moved from a kneeling position. The movable fence allows straight or 45° diagonal cuts at different areas under the 14" blade for extra blade life. Max. plank hardness: 1290 Janka scale. Max. plank width: 14". Max. diagonal cut: 9".

Order No.	Description	Weight
673	14" Wood Cutter	25.7 lbs.
672	14" Wood Cutter Blade	0.38 lb.
674	13" Wood Cutter Blade	0.36 lb.



**No. 673
14 inch**



**No. 679
9 inch**

No. 679 9" Wood Cutter

Cuts plank flooring up to 3/4" thick, including a variety of solid hardwood, engineered wood, laminate, and LVP planks. Features a movable fence to position the material on either side of the blade for more blade life. Max. plank hardness: 1290 Janka scale. Max. plank width: 9"

Order No.	Description	Weight
679	9" Wood Cutter	19.4 lbs.
681	9" Wood Cutter Blade	0.25 lb.





No. 562 Plastic Spacers (10)

These spacers maintain a proper size gap even when the adjacent wall is undercut. The V-shape rests against the face of the plank to prevent the spacer from tipping. The two ends have different thicknesses, one at $\frac{3}{16}$ " and the other at $\frac{1}{4}$ ", for various manufacturer's specifications.

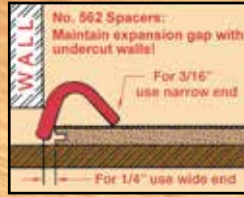

Order No.	Description	Weight
562	Plastic Spacers	5.28 oz.



No. 562

Crain Tapping Blocks

Made in two sizes from $\frac{3}{4}$ " thick solid plastic blocks. Both have relieved edges on a side and an end. Used to tap the side of the plank to fit the tongue and groove.

Order No.	Description	Weight
563	7" Tapping Block	9 oz.
569	11 $\frac{3}{4}$ " Tapping Block	1 lb.



No. 563
7 inch



No. 569
11 $\frac{3}{4}$ inch



No. 576 LVP Angle Tapping Block

Lifts the LVP plank to the angle where it can be tapped and locked tight. Large upper plastic block contacts just below the face of the plank, while a lower plastic contact plate slides to contact the core. Comes with three 1mm shims and two 3mm shims. Works on planks and tiles up to 10mm thick. Shims sold separately for thicker LVP/LVT.

Order No.	Description	Weight
576	LVP Angle Tapping Block	1 lb. 13 oz.
577	1mm Shim for LVP Block	1 oz.
578	3mm Shim for LVP Block	2 oz.
579	Contact Plate for LVP Block	1 oz.



LVP TAPPING BLOCK

No. 576



No. 560 "Knuckle Head" Pull Bar

This pull bar features a boxed "knuckle" hammering head that is welded to the body. The width has been increased to reduce body bending, and the length is increased for more working room at the wall.

Order No.	Description	Weight
560	"Knuckle Head" Pull Bar	3.25 lb.



BOXED & WELDED HAMMERING HEAD

No. 560



No. 285 LVP Scoring Knife

The 45° blade angle of this knife is optimal for scoring and breaking rigid core LVP/LVT. The wide beveled edge on the blades score the plank smoothly and reduce resistance. The elevated handle provides knuckle clearance. Extra blades are stored in the handle. Replacement blades: Crain No. 286C (100 pack) or No. 287 (10 pack).

Order No.	Description	Weight	Blades
285	LVP Scoring Knife	9.3 oz.	286C, 287



SCORE LVP

No. 285



SCORING BLADES:
No. 286C (100)
No. 287 (10)

No. 288 Hook Handle LVP Scoring Knife

The 45° blade angle of this knife is optimal for scoring and breaking rigid core LVP and LVT. The wide beveled edge on the blades score the plank smoothly and reduce resistance. The elevated handle provides knuckle clearance. Reversible blade holder takes LVP/LVT scoring blades or standard utility/hook blades. Blades can be stored in the handle.

Order No.	Description	Weight	Blades
288	Hook Handle LVP Knife	5.8 oz.	286C, 287



CUT VINYL & LINOLEUM

No. 288



REVERSIBLE
BLADE HOLDER

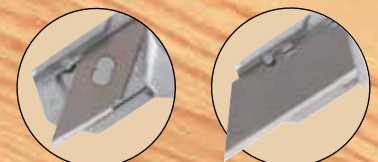



Metal Mitre Tools

"Click" and it's mitered! Metal Mitre tools make 90° triangular cuts in aluminum cap metals, allowing you to create corners without a miter box. The 8-to-1 leverage and all-steel construction of these tools make for easy cutting and long useful life.

Choose No. 849 Handle and Die Set Combo for most vinyl and carpet cap with at least a 3/32" opening. Choose the No. 851 Handle and Die Set Combo for vinyl and laminate cap metal with at least a 1/16" opening. Choose No. 847 Combo with extra-thick heavy duty punch for mitering other heavier cap (such as wallboard cap). Nos. 846, 848 & 850 die sets are interchangeable and sold separately.

The No. 870 Combo is used to notch vinyl mouldings for tight radius bends without wrinkles. It cuts out a 1/4" wide relief slot with 90° side angles. Sold as a combo die set and handle only. Durably constructed with heavy-duty punch.

Order No.	Description	Weight
845	Metal Mitre Handle Only	1 1/2 lbs.
846	.135" Punch Die Set Only	8 oz.
847	.135" Punch Die Set & Handle	2 lbs.
848	.090" Punch Die Set Only	8 oz.
849	.090" Punch Die Set & Handle	2 lbs.
850	.050" Punch Die Set Only	8 oz.
851	.050" Punch Die Set & Handle	2 lbs.
870	.156" Punch Vinyl Notcher	2 lbs.

No. 368 Deluxe Hacksaw & Blades

This sturdy, gleaming, nickel-plated steel frame is fully adjustable for 10" or 12" blades. The frame has a contoured plastic hand grip. Blade included.

Order No.	Description	Weight
368	Deluxe Hacksaw Frame	2 lbs.
369	12" Blade, 32T (Card of 2)	1 oz.

No. 176 Carpet Layer's Miter Box

Designed for carpet installers, this box is small and compact in size. All needed angles are included. The nickel-plated steel saw guides are absolutely accurate and case-hardened to prevent wear. A hardwood block bottom allows clean cuts through without dulling the hacksaw. Now equipped with nonslip non-marring pads on bottom.

Order No.	Description	Weight
176	Carpet Layer's Miter Box	3 lbs.

No. 855 Wood Miter

This tool is helpful for making fast angle cuts in quarter round. The sharp, heavy-duty blade is replaceable.

Order No.	Description	Weight
855	Wood Miter	14 oz.
856	Wood Miter Replacement Blade	1 oz.

No. 880 Vinyl Miter & Blades

This miter tool features a replaceable 2 3/8" long razor-sharp blade, for accurate cutting on vinyl mouldings, straight or at a 45° angle. Features 4-to-1 leverage, nickel-plated steel parts, and cushioned nonslip grips.

Order No.	Description	Weight
880	Vinyl Miter	1 lb.
881	Replacement Blades (3)	1 oz.

No. 543 Aviation Type Snips

These compound leverage metal snips feature tough alloy steel blades for long useful life. Positive-lock contour handles are vinyl-coated for comfort.

Order No.	Description	Weight
543	Aviation Snips	9 oz.



No. 851

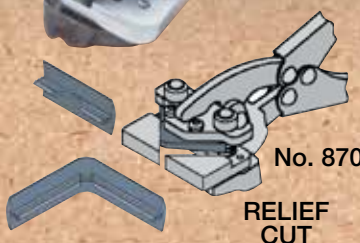
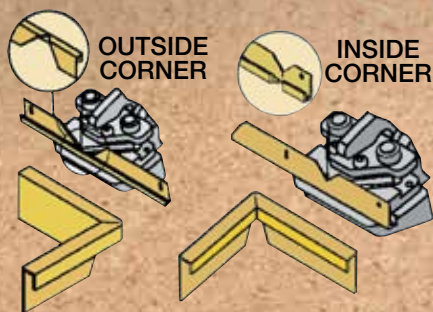

No. 870
RELIEF CUT



No. 368



No. 369



No. 855



No. 176



NEW!

22.5°

Soft corners



No. 880



No. 543



543

Other Tools



No. 336 Undercut Saw & Blades

This saw has a trapezoid-shaped high-carbon replaceable steel blade, with a 12" row of 10-point teeth on both sides. Perfect for undercutting door jambs and obstacles.

Order No.	Description	Weight	Blade / Wt.
336	Undercut Saw	1 lb.	335 / 8 oz.

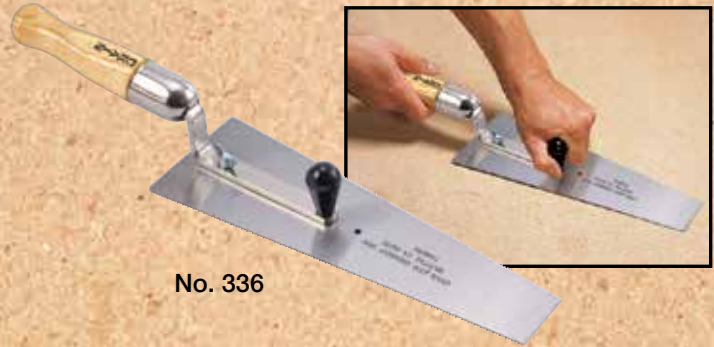

No. 336

No. 157 Crain Moulding Lifter

This steel pry bar is designed to get behind wood base and moldings and pry them off with a minimum of damage. Both the rocker and flat ends have slim, wide-profile prying surfaces that are polished smooth for safer insertion behind the base. Both ends have sharp, beveled nail slots with internal webbing for taking up small headed nails, brads, and staples often used on moldings.

Order No.	Description	Weight
157	Crain Moulding Lifter	8 oz.

No. 157

No. 159 Vaughan Superbar

The Vaughan 15" Superbar is the classic heavy-duty pry bar. Features a fully rounded "shepherd's crook" rocker end for maximum prying power, and a flat end for getting under nails and scraping. Includes three beveled nail slots. Both ends are polished for insertion behind moldings and base when used as a molding lifter.

Order No.	Description	Length	Weight
159	Vaughan Superbar	15"	24 oz.



No. 159

No. 401 6-in-1 Screwdriver

This screwdriver includes #1 and #2 Phillips tips, 3/16" and 5/16" slotted tips, and 1/4" and 5/16" nutdrivers. Made with a high-impact plastic ribbed handle for sure grip, and a heat-treated alloy steel socketed shaft.

Order No.	Description	Weight
401	6-in-1 Screwdriver	5 oz.



No. 401

No. 356 Carbide Hole Saw

This tungsten carbide hole saw cuts clean 1 3/8" holes for pipe clearance. The replaceable 1/4" masonry bit holds a center. An internal spring ejects the piece cut out. Works well on ceramic and soft-bodied quarry tile.

Order No.	Description	Weight
356	Crain Ceramic Hole Saw	10 oz.



No. 356

No. 684 Extension Cord

This 25 foot long 16 gauge 3 conductor grounded extension cord is constructed for use with power tools indoors or outdoors. Plug and receptacle are molded on the cord.

Order No.	Description	Max. Amp.	Weight
684	25 ft. Extension Cord	13	2 lbs.



No. 684

No. 353 Carbide Grout Saw

This hand saw is used for removing old or damaged grout. Comes with one carbide blade coated with carbide grit for cutting out grout between tiles, and one steel-toothed blade for heavy cleanout work after using the carbide blade. The steel-toothed blade can be used in combination with the carbide blade for wider grout joints or to protect walls when working up close to a wall. Minimum grout joint width: 1/8". Replacement blades: No. 353Y.

Order No.	Description	Weight	Blade / Wt.
353	Grout Saw (w/2 blades)	4 oz.	353Y / 1/2 oz.



No. 353Y

No. 353

No. 081 "GritEdge" Rod Saw Blades

Remington tungsten-carbide rod saw blades have a fine grit edge that is perfect for cutting ceramic and laminates. Makes cutting angles and curves easy.

Order No.	Description	Length	Weight
081	Rod Saw Blade	10"	0.5 oz.



No. 081



NEW! LIFT CONTROL VALVE FOR FINGERTIP CONTROL



No. 280 H.D. AIR LIFTER

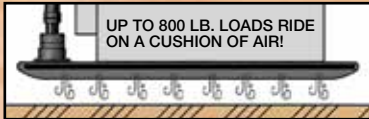

UP TO 800 LB. LOADS RIDE ON A CUSHION OF AIR!

No. 280 Heavy-Duty Air Lifter

The Air Lifter speeds-up the job of moving appliances and reduces the risks of damaging new floors or back injuries. Slide the wide air plates under the load, turn on the 2 HP blower, and the load is lifted. The convenient lift control valve controls how high the load is lifted. You then can move the load effortlessly! Includes: 2 air plates, lift control valve, 3 hoses, T-Connector, carrying bag, 2 HP blower & shoulder strap, and four carpet adapter glides.

Order No.	Description	Amps	Volts	Weight
280	H.D. Air Lifter	7.5	120	30 lbs.
281	Single Carrying Bag	--	--	3 lbs.

No. 015 & 016 Vinyl Dollies

These dollies are great for in-store and job uses. Sturdily constructed, with double ball bearing, heavy-gauge rollers, cast aluminum frames, and non-marking rubber wheels. Accepts rolls to 16" diameter. Available in two sizes.

Order No.	Size	Weight	Order No.	Size	Weight
015	18" Dolly	13 lbs.	016	36" Dolly	21 lbs.

No. 017 Metal Skat Skates

These dollies have steel adjustment arms and load plates. Rotating urethane wheels turn very easily and won't scratch floors. Load pads have thick vinyl covers. Great for moving furniture and appliances!

Order No.	Pad Size	Closed	Open	Capacity	Set Wt.
017	8" X 10"	24"	32"	1,000 lbs.	20 lbs.



No. 015

No. 016



No. 017

No. 018

No. 018 Tile Dolly

This tile dolly has a rugged 11" x 16" deck, five heavy-duty casters, and an ergonomic handle. Rolls and turns easily with up to five boxes of tile or approx. 300 lbs. The solid plastic wheels are attached to hardened swivel bracketry.

Order No.	Deck Size	Capacity	Weight
018	11" X 16"	300 lbs.	3.75 lbs.



No. 124



No. 024



No. 124 60" Carpet Cart

This cart has a full-sized 20" wide x 60" long bed providing support for long and heavy rolls up to 1000 lbs. The tubular steel frame is reinforced with central steel plates. Four eyelets are provided for tying down the load. The large diameter 16" pneumatic tubed tires are tall and wide enough to roll up curbs, steps, or across gravel.

Order No.	Description	Capacity	Weight
124	60" Carpet Cart	1,000 lbs.	42 lbs.

No. 354 Tool Pouch & No. 407 Square Tool Pouch

No. 354 – primarily a pocket pouch that can also hang on a belt. Knives wedge tightly inside. Made of durable leather.

No. 407 – wider and deeper for greater storage capacity. Hangs on belts. Constructed of durable leather.

Order No.	Description	Weight
354	Pocket Tool Pouch 4 ³ / ₈ " x 7 ¹ / ₂ "	8 oz.
407	Square Leather Pouch 4 ¹ / ₂ " x 7 ¹ / ₂ "	6 oz.

No. 024 Rolling 24" Tool Box

This fully featured yet lightweight 24" toolbox is made from advanced "structural foam" materials. The thick walls are very durable but without all the weight. Rolls level with the floor thanks to a top mounted pull handle. The tray has a series of angled recesses which allow steam to escape, while also keeping even pressure on the seam.

Order No.	Length	Width	Height	Weight
024	24"	10 ¹ / ₂ "	11 ¹ / ₄ "	16 lbs.

RECESSED TRAY BOTTOM VENTS HEAT AND STEAM

Crain Knee Pads



Comfort Knees Knee Pads

These knee-pads have protection for both kneeling and knee-kicking, so they stay on at all times. The extra-wide hook-and-loop straps won't pinch your legs, even when wearing shorts. All models are made from flexible yet durable neoprene. The black No. 199 has a thin bonded polyurethane skin on the kneeling surfaces for durability, and the brown No. 196 has extra thick polyurethane skin.

Order No.	Description	Weight
196	Heavy-Duty Comfort Knees	1 lb/set
197	Comfort Knees Knee Pads	1 lb/set
199	Polyurethane Skin Comfort Knees	1 lb/set



NEW
No. 196 Heavy-Duty Polyurethane Skin



No. 197 Plain Neoprene



No. 199 Polyurethane Skin

No. 198 Buckle Strap Knee Pads

Made of highly durable sponge rubber with 1/2" straps and buckles. Cushion feel is comfortable kneeling or standing.

Order No.	Description	Weight
198	Buckle Strap Knee Pads	1 lb/set

Knelling and knee kicker protection:



WIDE STRAPS DON'T PINCH



KNEE KICKER PROTECTION



MORE DURABLE

No. 200 Elastic Strap Knee Pads

Made of 1/2" thick sponge rubber with heavy-duty 1 1/2" wide elastic hook-and-loop straps that flex as you move.

Order No.	Description	Weight
200	Elastic Strap Knee Pads	1 lb/set

No. 206 Leather Knee Pads

These heavy-duty leather pads are durably constructed to last and last. Lined with a thick felt pad that's riveted to the leather, they come with heavy-duty straps and buckles.

Order No.	Description	Weight
206	Leather Knee Pads	1 3/4 lbs./set



Troxell Knee Pads

Troxell knee pads are ultra-soft and have wide straps to reduce pinching. Nos. 250 and 251 have polyurethane protective covering while No. 252 has synthetic leather.

Order No.	Description	Troxell No.	Weight
250	Troxell Soft R Knee Pads	17-209SOFT	0.68
251	Troxell Soft L Knee Pads	17-209SOFTL	0.75
252	Troxell XL Leather Head Pads	17-209SOFTXL	1.00

No. 223 & 224 Solid Carbide Drill Bits No. 225 & 226 Adaptors

These solid carbide drill bits are available in 1/8" and 3/16" sizes with adaptors available to fit your 1700 to 3500 r.p.m. electric drill. Both have two usable tips.

Order No.	Description	Weight
223	1/8" Solid Carbide Drill, Each	1 oz.
224	3/16" Solid Carbide Drill, Each	2 oz.
225	1/8" Hexagon Adaptor	2 oz.
226	3/16" Hexagon Adaptor	2 oz.

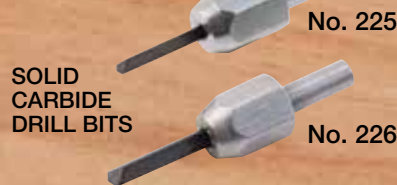
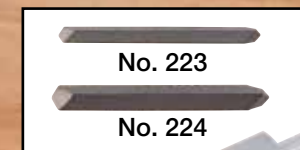

SOLID CARBIDE DRILL BITS

No. 455 Strip Saver Bag

This heavy-duty cloth bag slips over standard 4 ft. long strip boxes. It prevents bursting of boxes and looks professional on the job. Reinforced end panel, heavy-duty zipper, and double-stitched handle for a long, useful life.

Order No.	Description	Weight
455	Strip Saver Bag	1 1/2 lbs.



No. 455



CRAIN

Trowels & Spreaders



NEW
No. 439

Nos. 420-433 Notched Trowels

No. 434 4" x 14" Finishing Trowel

No. 439 4" x 16" Finishing Trowel

Crain Professional Trowels are made with curved wooden handles and hardened spring steel blade. Nos. 420, 421, 422, 424, 430, 431 and 433 have an angled back front edge for clearance when spreading close to walls. Nos. 423, 425, 426, 427, 428, 429 and 432 have a square front edge. Nos. 422 and 423 only are available in left hand models - add "L" after the Order No. for left. The No. 434 4" x 14" Finishing Trowel (square corners), and No. 439 4" x 16" Rounded Corner Finishing Trowel (rounded corners) do not have notches for use in spreading patch.

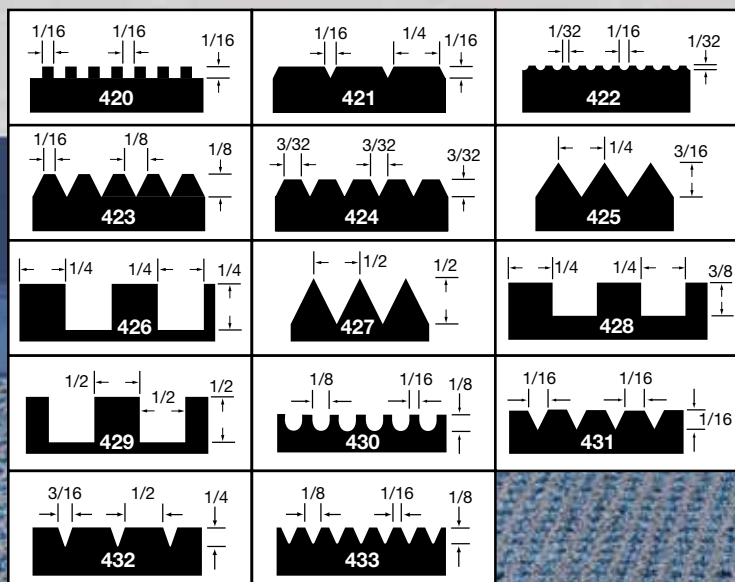

Order No.	Open	Flat	Depth	Shape	Weight
420	1/16"	X	1/16"	Square	1 lb.
421	1/16"	X	1/4"	V	1 lb.
422	1/16"	X	1/32"	U	1 lb.
423	1/8"	X	1/16"	V	1 lb.
424	3/32"	X	3/32"	V	1 lb.
425	1/4"	X	3/16"	V	1 lb.
426	1/4"	X	1/4"	Square	1 lb.
427	1/2"	X	1/2"	V	1 lb.
428	1/4"	X	1/4"	Square	1 lb.
429	1/2"	X	1/2"	Square	1 lb.
430	1/8"	X	1/16"	U	1 lb.
431	1/16"	X	1/16"	V	1 lb.
432	3/16"	X	1/2"	V	1 lb.
433	1/8"	X	1/16"	V	1 lb.
434	4"x14" Finishing Trowel				14 oz.
439	4"x16" Rounded Corner Finish Twl.				15 oz.

No. 038 / 039 Econo Notched Spreaders

No. 040 / 041 Notched Spreaders

The Nos. 038 and 039 spreaders have polished spring steel blades and black plastic handles. The Nos. 040 and 041 spreaders have stainless steel blades and wood handles. Both have V-shaped notches 1/8" wide by 1/8" deep for spreading base adhesive.

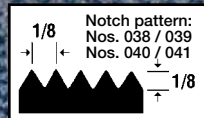

Order No.	Description	Notch	Weight
038	3" Economy Spreader	1/8" x 1/8"	3 oz.
039	4" Economy Spreader	1/8" x 1/8"	3 oz.
040	3" Notched Spreader	1/8" x 1/8"	2 oz.
041	4" Notched Spreader	1/8" x 1/8"	2 oz.

No. 203 Glue Gun, Nozzles & Sticks

No. 203 is a heavy-duty, trigger-fed, glue gun with 80 watts of heating power, complete with an 1/8" extension nozzle. Users are cautioned to avoid contact with hot melted glue as it can cause severe burns, and to keep out of the reach of children.

Order No.	Description	Watts	Weight
203	Glue Gun	80	10 oz.
201	10" Glue Sticks - 19 Stick Pk.	- - -	1 lb.
202	4" Glue Sticks - 24 Stick Pk.	- - -	8 oz.
628	1/4" Nozzle	- - -	1 oz.
629	1/8" Nozzle	- - -	1 oz.



Nos. 628 & 629

Cove Base Tools



No. 235 6" Disposable Cove Nozzle No. 236 3" Disposable Cove Nozzle

These low-priced throw-away cove base nozzles evenly spread adhesive. They attach quickly onto the plastic tip of cartridges. No. 235 lays down 5 beads for 6" base. No. 236 lays down 3 beads for 3" base. Both fit most popular cartridge guns.

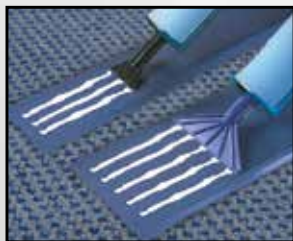

Order No.	Description	Weight
235	6" Disposable Cove Nozzle	1 oz.
236	3" Disposable Cove Nozzle	1 oz.



No. 237 & 238 Cove Base Guns

Primarily used for applying cove base adhesive, they are designed for the job. They feature all-steel construction, and a smooth rod push mechanism.

Order No.	Description	Capacity	Weight
237	Cove Base Glue Gun	1 qt.	2.5 lbs.
238	Cove Base Glue Gun	1/10 gal.	1 lb.



No. 530 Rubber Base Gouge

This tool for gouging out the back of rubber or vinyl base for tightly-wrapped corners comes with a double-tipped blade. The V-tip makes a sharp V-shaped groove that conforms better to tightly formed sheetrock corners. The U-Tip makes a wider U-shaped groove for fuller corners, or for tougher base where a wider groove must be made.

Order No.	Description	Weight
530	Rubber Base Gouge	5 oz.
531	Gouge Replacement Blade	1 oz.



No. 532 Topset Gouge

This tool gouges the back of vinyl or rubber cove base to produce tight-wrapped corners. The 5/32" wide blade adjusts for depth and can be sharpened.

Order No.	Description	Weight
532	Topset Gouge	3 oz.
533	Replacement Blade	1 oz.

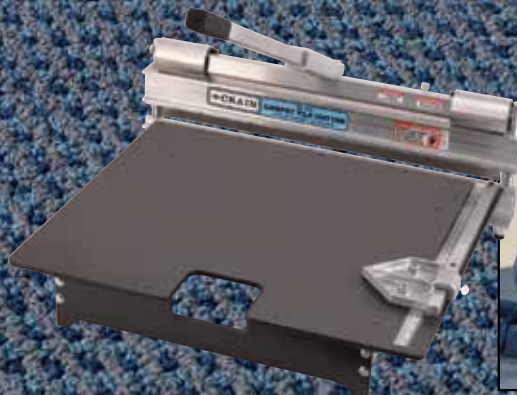

No. 532 Gouges back for tight corners!

No. 675 24" Carpet Tile Cutter

Cuts carpet tiles, vinyl tiles, LVT planks, and rubber tiles 24" straight or 18" on a diagonal. Handles materials up to 3/4" thick per cut. Built-in wheels allow it to be moved easily from a kneeling position. The movable fence and tile guide can be set for repetitive straight or diagonal cuts.

Order No.	Description	Weight
675	24" Carpet Tile Cutter	38 lbs.
676	Carpet Tile Cutter Blade	0.7 lb.



REPLACEMENT BLADES BY ORDER NUMBER

REPLACEMENT BLADES BY ORDER NUMBER

REPLACEMENT BLADES BY ORDER NUMBER

TOOL NO.	BLADE NO.
005	012 013 026A
006	025A 026A
070	295C 996X 997
174	1174-A
175	177
189	295C 996X 997
217	306C 308C 309C
245	184 184C
246	184 184C
247	306C 308C 309C 996X 997
265	295C 996X
285	286C, 287
288	286C, 287, 295C, 341, 342, 996X, 997
290	295C 306C 308C 309C
297	300Y
298	299Y
300	300Y 306C 308C 309C
301	306C 308C
302	306C 308C 309C
303	306C 308C 309C
304	295C 300Y 308C
305	306C
320	321
340	341 342
350	351 351C
360	351 351C
375	376 377
375S	376 377
390	391
450	451
523	523Y
725	306C 308C 309C
726	306C 308C 309C
727	295C 996X 997
728	295C 996X 997
730	295C 996X 997
732	295C 996X 997
735	306C 308C 309C
880	881

GUNDLACH		TUCK KNIFE		TRIMMER	
012 WARD STANDARD	013 WARD HEAVY	026A AIRWAY HOOK STRAIGHT	177 TUCK KNIFE REPL. BLADE	184 UNIVERSAL TRIMMER BLADE	184C UNIVERSAL TRIMMER BLADE
L 2.35 W .480 T .025 PK 12 WT 1.1 oz.	L 2.68 W .736 T .025 PK 12 WT 1.7 oz.	L 2.125 W .495 T .025 PK 12 WT 1 oz.	L 4.00 W 2.21 T .065 PK 1 WT 1 oz.	L 2.18 W .75 T .017 PK 10 WT 1 1/4 oz.	L 2.18 W .75 T .017 PK 10 WT 1 1/4 oz.
231 DELUXE SCRAPER BLADES	232 DELUXE SCRAPER BLADES	287 PERSONNA LVT/LVP BLADES	295C HEAVY DUTY UTILITY BLADES	299Y TOP CUTTER BLADES	300Y LOOP PILE CUTTER BLADES
L 7.50 W 2.00 T .090 PK 12 WT 6 oz.	L 7.50 W 3.00 T .091 PK 12 WT 10 oz.	L 1.625 W .750 T .025 PK 10 WT 10 oz.	L 2.40 W .75 T .025 PK 10 WT 15 oz.	L 3.0 W .745 T .025 PK 10 WT 3 oz.	L 2.31 W .75 T .025 PK 10 WT 2 oz.

GROUPT SAW		STRIPPER BLADES		VINYL MITRE	
353Y GROUPT SAW BLADES	351 FLOOR STRIPPER BLADES	351C FLOOR STRIPPER BLADES	687 REPAIRMENT PIN	881 REPAIRMENT BLADES	881 REPAIRMENT BLADES
L 2.00 W .750 T .032 PK 2 WT 1/2 oz.	L 4.00 W .560 T .020 PK 10 WT 1.2 lb.	L 4.00 W .560 T .020 PK 10 WT 2 oz.	L 5.00 W .375 PK 1 WT 2 oz.	L 2.4 W .75 T .040 PK 3 WT 1 oz.	L 2.4 W .75 T .040 PK 3 WT 1 oz.

VINYL TRIMMER		SEAMMATE		CARPET PEELER	
321 VINYL WALL TRIMMER BLADES	351 FLOOR STRIPPER BLADES	523Y 23" SEAMMATE	687 REPAIRMENT PIN	881 REPAIRMENT BLADES	881 REPAIRMENT BLADES
L 2.34 W .500 T .025 PK 3 WT 1 oz.	L 4.00 W .560 T .020 PK 10 WT 2 oz.	L 23.27 W .560 T .020 PK 3 WT .30 lb.	L 5.00 W .375 PK 1 WT 2 oz.	L 2.4 W .75 T .040 PK 3 WT 1 oz.	L 2.4 W .75 T .040 PK 3 WT 1 oz.

SCRAPER BLADES		REPAIR TOOL	
376 BIG SCRAPER BLADES	377 BIG SCRAPER BLADES	1174-A INSTANT REPAIR BLADES	1174-A INSTANT REPAIR BLADES
L 8.00 W .750 T .037 PK 3 WT 4 oz.	L 8.00 W .750 T .037 PK 9 WT 9 oz.	L 1.87 W .48 T .040 PK 12 WT 1 oz.	L 1.035 W .500 T .020 PK 4 WT 2 oz.

HAND GROOVER		HOOK BLADES	
956 PULL HAND GROOVER REPL. BLDS.	996X HOOK BLADE	997 PERSONNA DEEP HOOK	997 PERSONNA DEEP HOOK
L 0.856 W .594 T .042 PK 3 WT 1/2 oz.	L 2.0 W .735 T .025 PK 15 WT 2 oz.	L 2.0 W .750 T .025 PK 10 WT 2 oz.	L 2.0 W .750 T .025 PK 10 WT 2 oz.

REPAIR TOOL		REPAIRMENT PIN	
1174-A INSTANT REPAIR BLADES	1174-A INSTANT REPAIR BLADES	687 REPAIRMENT PIN	687 REPAIRMENT PIN
L 1.035 W .500 T .020 PK 4 WT 2 oz.	L 1.035 W .500 T .020 PK 4 WT 2 oz.	L 5.00 W .375 PK 1 WT 2 oz.	L 5.00 W .375 PK 1 WT 2 oz.

REPAIRMENT WHEELS FOR CRAIN CERAMIC TILE CUTTERS		REPAIRMENT WHEELS FOR CRAIN CERAMIC TILE CUTTERS	
No. 046 7/8" Carbide Wheel	No. 046 7/8" Carbide Wheel	No. 400 1/2" Carbide Wheel	No. 400 1/2" Carbide Wheel
For Crain No. 045 Super Quarry Tile Cutters ONLY	Fasteners not included	For Crain Nos. 030, 031, 032X, and 033X Ceramic Tile Cutters.	Fasteners included
Weight: 1 oz. contains one each	Weight: 1 oz. contains one each	Weight: 1 oz. contains one each	Weight: 1 oz. contains one each

REPL. BLADE FOR No. 338 FLEX UNDERCUT SAW



No. 339 Flex Undercut Blade
 ■ Double row of fine induction hardened teeth. Weight: 4 1/2 oz.

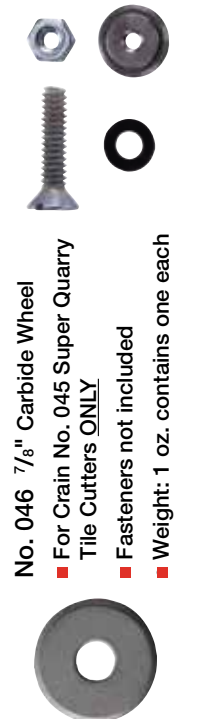

Floor Covering Tools Catalog - Table of Contents



A	E	Multi-Undercut Saw2	Cases4
Acrylic Glue Sticks13	Electric Staplers14	N	Power Stretchers3, 4, 5
Adhesive Syringe.....20	Extension Cords28	Needles:	Seam Repair5
Aluminum Drives13	F	Carpet Sewing12	Stairway5
Appliance Movers: Air Lifter.....29	Floor Scrapers, Hand18	Scriber.....24	Stretcher Tubes4
Awls, Carpet12	Floor Stripper, Power.....17	Notcher:	Strip Cutter, Tackless13
B	G	Vinyl.....27	Strip Glue Guns32
Base, Cove Base Tools32	Glue:	P	Strip Saver Bag.....30
Blades:	Acrylic Hot Melt Sticks13	Pin Vise24	Strippers, Floor, Hand18
Airway22	Hot Melt Gun & Stick...9, 13, 31	Plastic Laminate Roller20	Strippers, Machine17
Diamond.....1, 2, 23	Spreaders.....31	Pouches, Leather Tool.....29	Superbar28
Discontinued Saws.....24	Goggles, Safety14	Power Groover, Vinyl23	Syringe, Adhesive20
Knife15, 16, 22, 24, 26, 33	Gouge, Cove Base32	Power Stretchers.....3, 4, 5	T
Razor Blades, Replaceable...33	Groovers, Vinyl23, 24	Power Stripper.....17	Tack Strip
Saws.....1, 2, 23, 24	Grout Saw & Blades28	Pull Bar, Laminate & Hardwood ...26	Tools.....13
Scraper.....18, 33	H	R	Hot Melt13
Seammate.....33	Hacksaw & Blades.....27	Repair Tools, Carpet.....5, 16	Tacker, Electric14
Stripper Machine17	Half Hatchet.....13	Replacement Razor Blades33	Tapping Blocks26
Trimmer11, 21, 33	Hammers & Mallets12, 13	Resilient:	Thread & Thimbles12
Usage Table33	Hardwood Tools.....25, 26	Knives22	Tile Cutters:
Vinyl Groover23, 24	Heat Bond Irons & Kits.....10	Rollers20	Carpet32
Ward.....22	Heat Guns24	Scribers.....21	Resilient/Vinyl19
Other (Look Under Tool)	Heat Weld Gun23	Trimmers, Selvage & Wall.....21	Tile, Ceramic:
Blocks: Tapping26	Hole Saw, Ceramic28	Rod Saws.....28	Tools.....28
Bottles:	Hot Air Guns24	Rollers:	Repl. Wheels for Cutters33
Carpet Seam Sealer11	Hot Melt Glue Guns9, 13, 31	Carpet Seaming.....10	Toe-Kick Saw Blades2, 24
Brushes.....18	I	Linoleum (Vinyl, Resilient)20	Tool Boxes29
C	Inside Corner Saw1, 2	Plastic Laminate20	Tool Kit, Carpet.....12
Carpet:	Inside Cove Corner Kit21	Row Separator.....9	Tool Kit, Vinyl Welding.....23
Awls.....12	Irons, Carpet Seaming10	Rubber Mallet12	Tool Pouches29
Cart.....29	J	S	Topset Base Tools32
Claw, Pulling18	Jamb Saws:	Safety Glasses.....14	Trim Line Vinyl Corners19
Edge Sealing.....9, 11	Hand Undercut Saw28	Safety Floor, Diamond Blade23	Trimmers, Carpet.....7, 11
Knives15, 16	Power Undercut Saws.....1, 2	Saws:	Trimmers, Vinyl11, 21
Seam Rollers.....10	K	Discontinued Saw Blades24	Trowels.....31
Seaming Irons.....10	Kit, Carpet Installers.....12	Inside Corner1, 2	Tubes, Stretcher4
Stretchers3, 4, 5	Kit, Vinyl Welding.....23	Jamb1, 2, 28	Tuck Knife16
Tile Cutter32	Knee Kickers.....6	Rod.....28	Turning Tool12
Tractor.....10	Knee Pads.....30	Toe-Kick2	U
Trimmers11	Knives:	Undercut1, 2, 28	Undercut Saws1, 2, 24, 28
Tuckers.....12	Airway22	Scoring Knife, LVP.....26	Utility Knives.....16, 22, 24, 26
Ceramic Grout Saw28	Carpet15, 16	Scrapers, Floor18	V - Z
Ceramic Hole Saw28	Dexter.....22	Screwdriver, 6-in-128	Vinyl:
Chalk Line Reels & Chalk12	LVP/LVT Scoring26	Scribers & Needles.....21, 24	Knives22
Clamps, Plank.....25, 26	Pad15	Sealer	Miter27
Combination Straight Edges.....8	Utility16, 22, 24, 26	Carpet Seam Edge9, 11	Rollers20
Cookie Cutter.....16	Vinyl.....22	Hot Melt9	Tile Cutters.....19
Corners:	Ward22	Seaming, Carpet:	Trimmers, Selvage & Wall .11, 21
Metal for Coves (TrimLine)19	L	Cutters7	Welding Tools23, 24
Cove, Inside Corner Kit21	Laminate:	Edge Sealer Bottle.....11	Wood Cutter25
Cove Base Gun & Nozzles32	Flooring Tools25, 26	Irons10	Wood Miter27
Cutters:	LVP/LVT Tools25, 26	Repair Stretcher5	“Z” Bar Trimmer.....7
Carpet Seaming.....7	Linoleum:	Rollers, Carpet Seam10	
Carpet Tile32	Dollies29	Squeezer9	
Vinyl Tile.....19	Knives22	Sharpening Stones.....16	
Wood.....25	Rollers20	Shears, Carpet.....9	
Cutting Wheels, Tile33	M	Skiving Knives, Vinyl23, 24	
D	Magnetic Driving Bar.....13	Snips27	
Dividers.....19	Magnetic Tack Holder13	Spacers, Laminate Floor25, 26	
Dollies:	Mallets, Rubber12	Spreader, Adhesive31, 32	
Skat Skate.....29	Metal Miter Tools27	Spreader, Carpet5	
Tile Dolly29	Mini Carpet Stretcher.....5	Stair Claw.....14	
Vinyl Dolly29	Miter Box27	Stair Tools12	
Door Pin Tools13	Miter, Wood.....27	Staple Remover.....14	
Drill Bits, Solid Carbide.....30	Mitering Tools27	Staple Saver Boxes14	
Drives, Aluminum13	Moulding Lifter28	Staplers & Staples14	
Driving Bar13		Straight Edges & Squares8	
Dust Pan & Duster.....18		Stretchers:	
		Accessories4, 5	

CRAIN NEW FOR 2025

No. 673 14" WOOD CUTTER



No. 246 CARPET TRIMMER



New more compact design improves your control over the length of trim. Tool is lighter, cuts smoothly, and changing blades is fast.

